

Wireless Doorbell

MODEL:

DK250

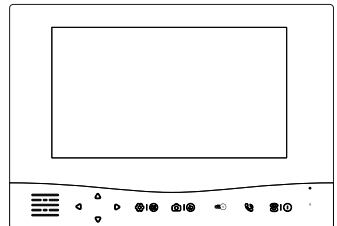
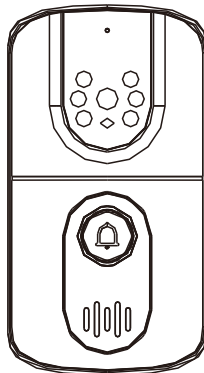

REMARK

Please follow the user manual for correct installation and testing. If there is any doubt please call our tech-supporting and customer center.

Our company applies ourselves to reformation and innovation of our products. No extra notice for any change. The illustration shown here is only for reference. If there is any difference, please take the actual product as the standard.

The product and batteries must be handled separately from household waste. When the product reaches the end of service life and needs to be discarded, please contact the local administrative department and put it in the designated collection points in order to avoid the damage to the environment and human health caused by any disposal. We encourage recycling and reusing the material resources.

CATALOG

Product Features	1
Package Contents	1
Pictures	2
Installing Batteries	4
Installation Instruction	6
Diagram	7
Settings	9
Engineering Mode	19
Operations	21
Technical Parameters	23
Installation & Usage	25
Safety Instructions	27



PRODUCT FEATURES

- 7" TFT LCD display
- Video resolution: 800x480, with 15 frames per second
- Wide angle lens and LED for night vision
- Long standby door camera (battery or DC 12V)
- Waterproof door camera IP65
- Microphone and speakerphone
- Basic video intercom, monitoring, remote unlocking and tamper alarm feature
- Adjustable brightness and talking volume
- Support up to 2 door cameras and 2 indoor monitors
- Transmitting distance: up to 400m range in open area
- DIY installation to save labor cost

PACKAGE CONTENTS

Please make sure the package contains the following items:

Contents of door camera

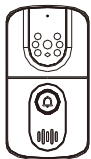

Door Camera



Battery Cover



Cable Cover

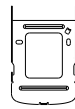

Bracket



Screws



Screw Wrench



User Manual

Contents of indoor monitor

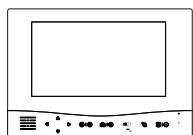

Indoor Monitor



Lithium Battery



Power Adapter
(12V, 500mA)



Bracket



Screws

PICTURES

Door Camera

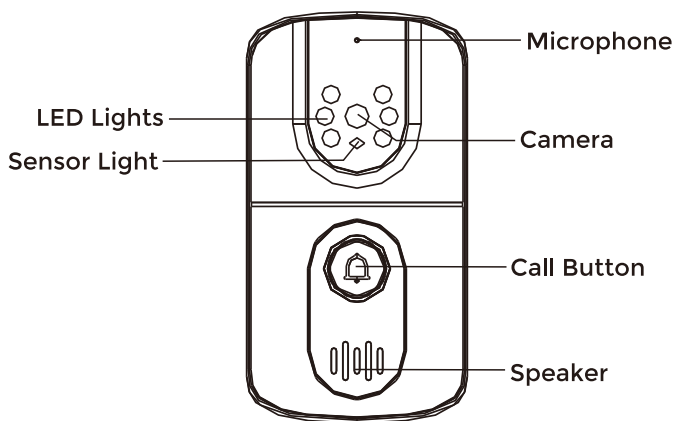

Indoor Monitor

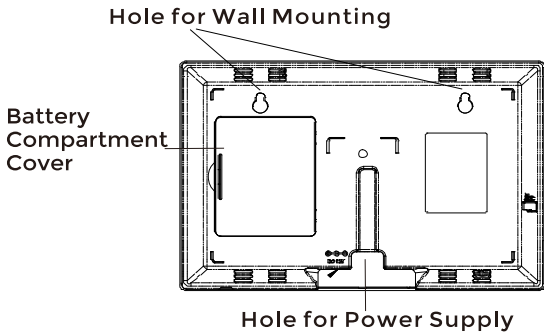
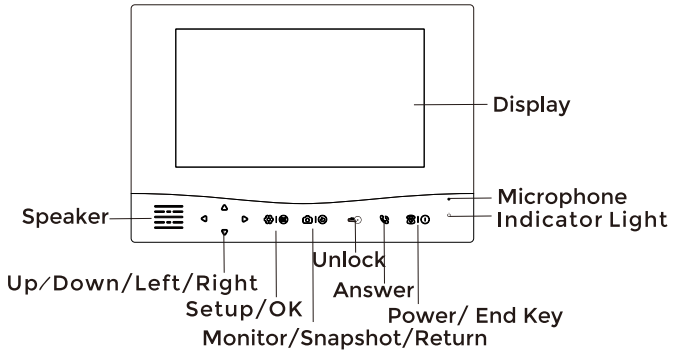

INSTALLING BATTERIES

Indoor Monitor

The rechargeable lithium battery (3.7V, 2500mA) comes with indoor monitor. Install the battery before use.

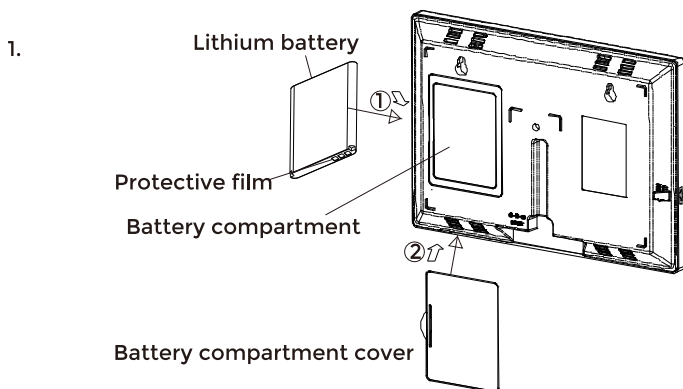

2. Insert new battery as indicated, matching correct polarity(+,-).
3. To replace the battery, slide the cover up until it snaps in place.

Notes:

1. To activate battery please remove protective film from the battery prior to use.
2. The battery needs to be replaced if it doesn't recover its full storage capacities after recharging.
3. When replacing the battery, make sure using good quality re-chargeable lithium battery. Never use other battery or conventional alkaline battery.

Door Camera

1. Install two 1.5V size C batteries (not supplied) into the battery compartment or connect with DC 12V power adapter to turn on the door camera.
2. Drill four screws to fix the battery cover up.

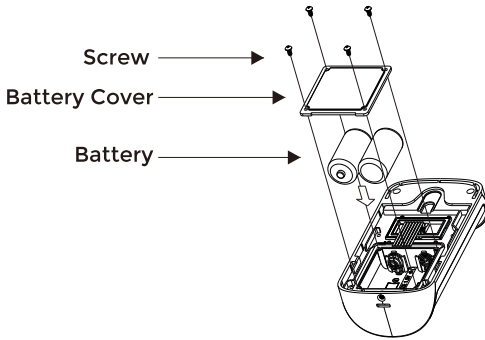

INSTALLATION INSTRUCTION

Indoor Monitor

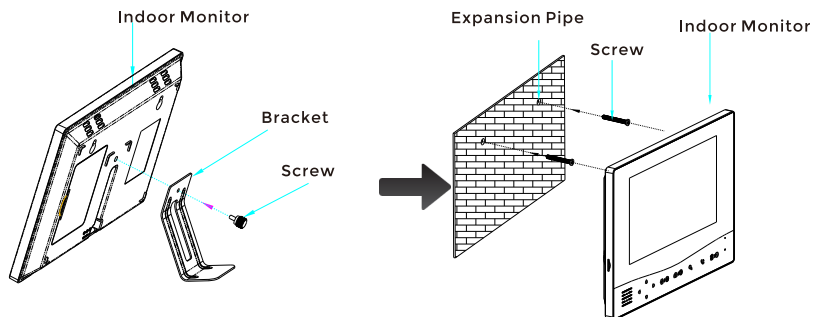

Charging Indoor Monitor

! Important Note: Before initial operation, **YOU SHOULD FULLY CHARGE THE INDOOR MONITOR** for about 5 hours.

Installation Notes:

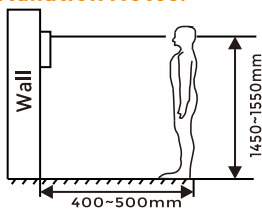

[Suggestion]: During the installation, the display screen should be 1450-1550mm from the ground.

DIAGRAM

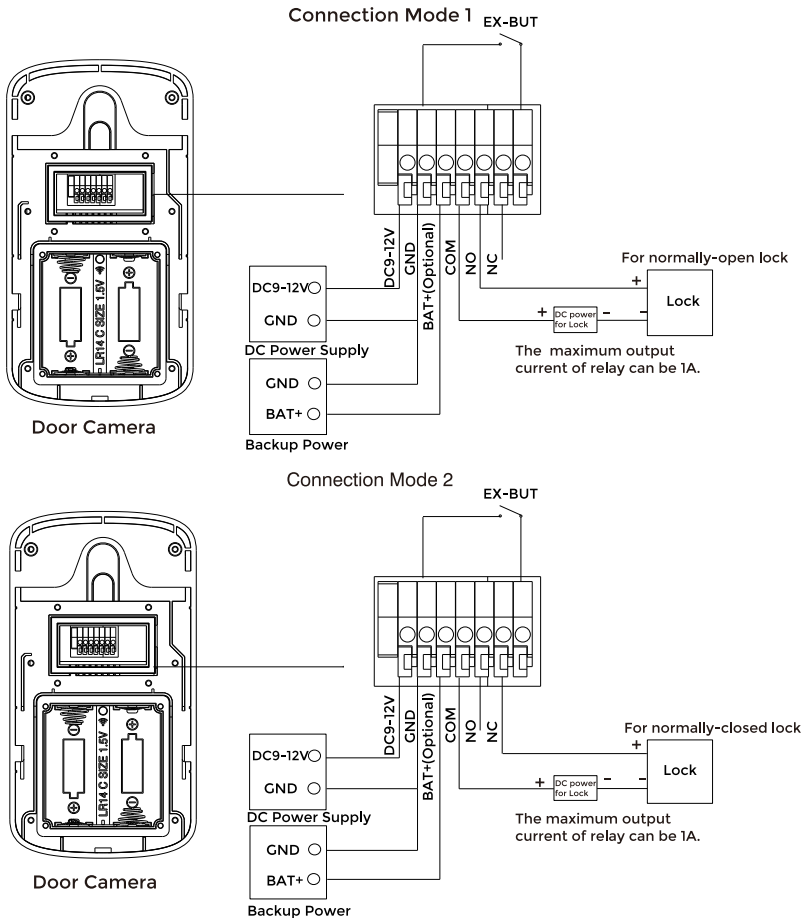

Note: The door camera can be powered by the batteries or the power adapter(not included). Do not use batteries and power adapter. The monitoring feature is available by default when the door camera is powered by power adapter. If the door camera is powered by batteries, the monitoring feature is not available until the power mode is changed to power consumption mode (see page 21).

Door Camera

1. After wiring from the connection terminal, tighten the cable. Drill the screws on the cable cover of the connection terminal.

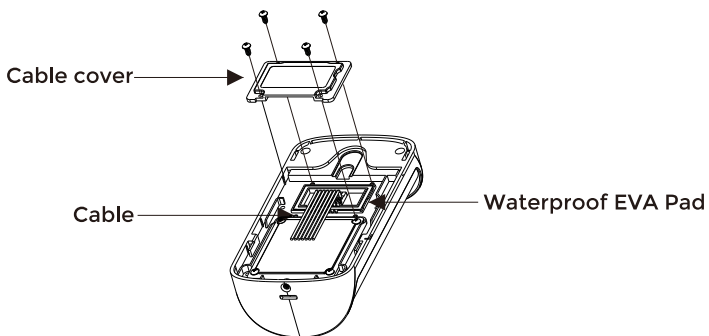

2. Choose a proper location for the door camera. Be sure to consider the average height of visitors. Drill screws to fix bracket on the wall. Hang the door camera on the bracket. Drill screws to fix door camera and finish the installation.

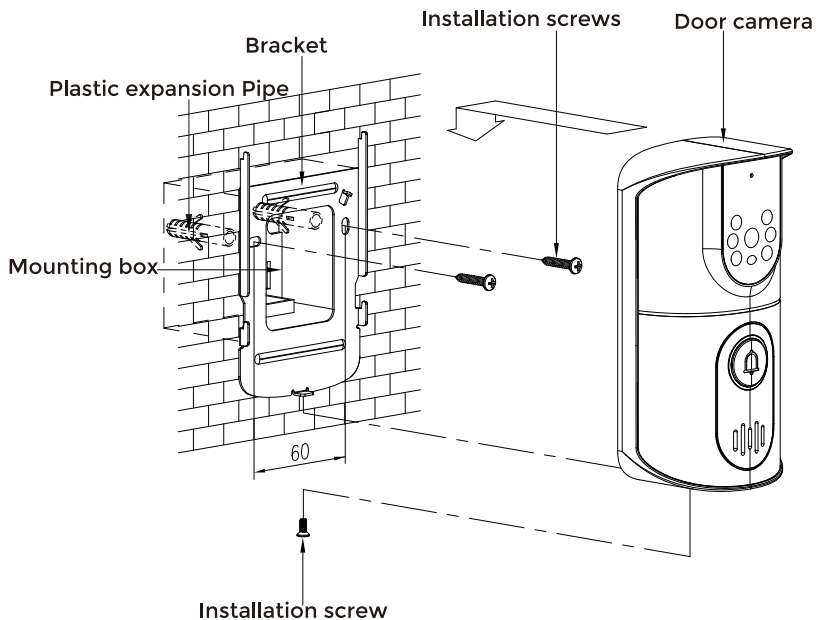



SETTINGS

Turning On

To turn on the indoor monitor, press and hold .

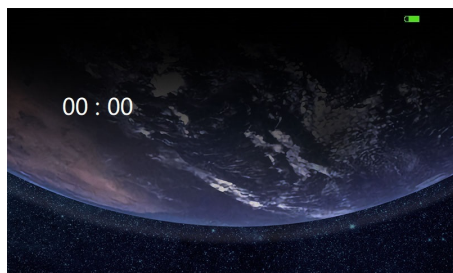
Powering on the indoor monitor, the system will enter into the following interface:



Note: When the battery power of indoor monitor is insufficient, it will display an indication icon  and emit warning tone. The indoor monitor will automatically turn off. You need to charge it.

Press  on the indoor monitor, then the system will enter into the following interface:

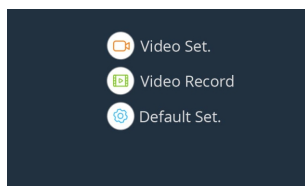
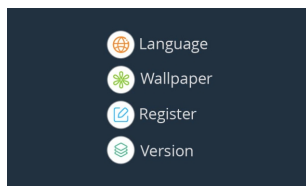
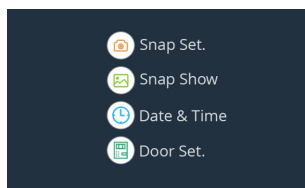
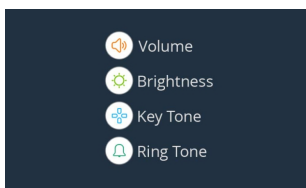

Chapter 1: Volume



This function allows you to adjust the volume (9 levels are adjustable) during a call.

1. Press Up Δ or Down ∇ to choose "Volume" menu, then press the button OK on indoor monitor.
2. Press Up Δ or Down ∇ to choose talking volume(9 levels are adjustable), and press Left \triangleleft or Right \triangleright to adjust.
3. Press Up Δ or Down ∇ to choose ringtone volume(9 levels are adjustable), and press Left \triangleleft or Right \triangleright to adjust.
4. To set the ringing time, you can press Up Δ or Down ∇ to choose Ringing Time(1-30 seconds are selectable), and press Left \triangleleft or Right \triangleright to adjust.
5. When setting Ringing Time at 0s, indoor monitor is on mute.
6. Press OK to save the settings and return to the previous menu.

Note: You can also press Left \triangleleft or Right \triangleright key to adjust the ringtone volume in the standby mode.

Chapter 2: Brightness

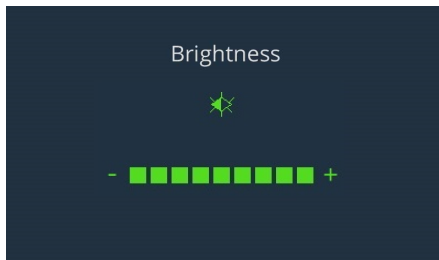

This function allows you to adjust the brightness (9 levels are adjustable).

1. Press Up Δ or Down ∇ to choose "Brightness" menu, then press OK .

2. Press Left ◀ or Right ▶ to select the brightness level. Each time you press Left ◀ or Right ▶ , the indoor monitor displays with the selected brightness level .

3. Press **OK** to save the settings and return to the previous menu.

Note: You can also press Up Δ or Down ▽ key to adjust the brightness in the standby mode.

Chapter 3: Key Tone

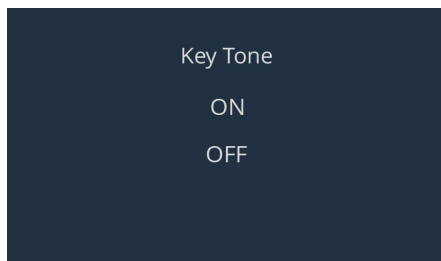

When the key is pressed, the indoor monitor acknowledges it with a key tone. Key tone can be disabled. In certain error conditions, there will be a warning tone when an incorrect key is pressed.

1. Press Up Δ or Down ▽ to choose “Key Tone” menu, then press **OK** .
2. Press Up Δ or Down ▽ to choose On or Off to enable or disable the function.
3. Press **OK** to save the settings and return to the previous menu.

Chapter 4: Ring Tone



This function allows you to change the ring tone of indoor monitor (There are three ring tones for your selection).

1. Press Up Δ or Down ∇ to choose “Ring Tone” menu, then press OK to confirm .
2. Press Up Δ or Down ∇ to select the ring tone . Each time you press Up Δ or Down ∇ , the indoor monitor rings with the selected volume.
3. Press OK to save the settings and return to the previous menu.

Chapter 5: Snap Set.

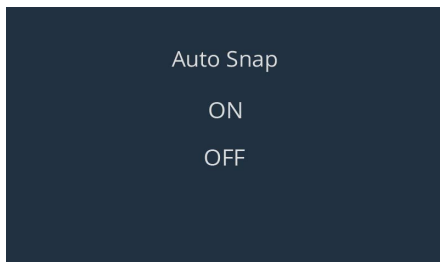

1. Press Up Δ or Down ∇ to choose “Snap Set.” menu, then press OK .
2. Press Up Δ or Down ∇ to choose On or Off to enable or disable the function.
3. Press OK to save the settings and return to the previous menu.

With this Auto Snap On, the camera will take a photo of visitor automatically when the visitor presses the Call button on the door camera. You can check this photo easily in the indoor monitor.

Notes:

1. During the conversation, if you press the Snapshot key, the camera can take a photo of visitor and save it into the indoor monitor.
2. During the monitoring, if you press the Snapshot key, the camera can take a photo of the view and save it into the indoor monitor.
3. Up to 75 photos can be stored in the monitor. The previous ones will be removed automatically if the photos are more than 75 pieces in the indoor monitor.

Chapter 6: Snap Show



You can view or delete recorded photos in this menu. Door station number, missed call icon or the door camera's PIR icon will be displayed at the top of photos correspondingly.

1. Press Up Δ or Down ∇ to choose "Snap Show" menu.
2. Press OK , and press Left \triangleleft or Right \triangleright to view pictures.
3. To delete the photo, press Left \triangleleft or Right \triangleright to choose the photo and then press OK . The display will show "🗑️?". Press OK to confirm.
4.  This icon means Delete All. Pressing Unlock key, the system will prompt whether to delete all the photos. Press OK to delete and press Return to exit.
5. After one warning tone, it will display next photo.
6. Press Home to return to the previous menu.

Chapter 7: Date&Time

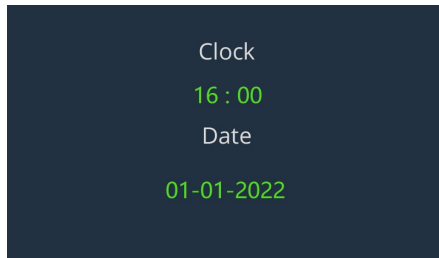

1. Press Up Δ or Down ∇ to choose “Date&Time” menu, then press OK to Select.
2. To set the time, you can press Left \triangleleft or Right \triangleright to choose the Hour or the Minute and press the Up Δ or Down ∇ to adjust.
3. To select the date, you can press Left \triangleleft or Right \triangleright to choose the Year or the Month or the Date, and press the Up Δ or Down ∇ to adjust.
4. Press OK to save the settings and return to the previous menu.

Notes:

1. Use 24-hour system as time format and DD-MM-YYYY as date format.
2. Date & Time must be set in advance to ensure that the time displayed on the indoor monitor is correct.
3. After replacing the battery, please set the time and the date again.
4. The Date & Time setting order is Hour-Minute-Year-Month-Date.

Chapter 8: Door Set.

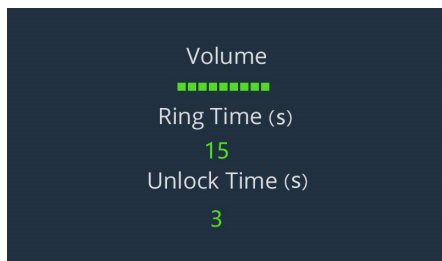

1. Press Up Δ or Down ∇ to choose “Door Set.” menu, then press OK .
2. To adjust the volume of door camera, you can press Up Δ or Down ∇ to choose (9 levels are adjustable), and press Left \triangleleft or Right \triangleright to adjust.
3. To set the ring time, you can press Up Δ or Down ∇ to choose Ring Time(1-15 seconds are selectable. When two indoor monitors are connected to one door camera, if the time set in two indoor monitors is different, the time is subject to the shorter one), and press Left \triangleleft or Right \triangleright to adjust.
4. If setting Ringing Time at 0s, door station will not make a sound when the call button is pressed.

5. If you want to set the unlock time, you can press Up Δ or Down ∇ to choose Unlock Time(1-9 seconds are selectable), and press Left \triangleleft or Right \triangleright to adjust.

6. Press OK to save the settings and return to the previous menu.

Note: When two indoor monitors are connected to one door camera, the settings of these two indoor monitors should be the same.

Chapter 9: Language

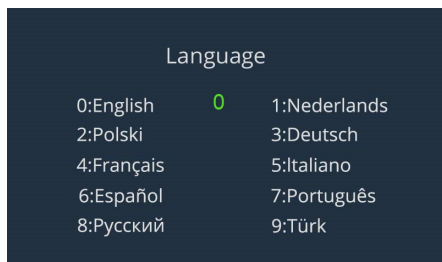

1. Press Up Δ or Down ∇ to choose "Language" menu, then press OK .

2. Press Up Δ or Down ∇ to choose the corresponding language(0 stands for English, 1 stands for Dutch, 2 stands for Polish, 3 stands for German, 4 stands for French, 5 stands for Italian, 6 stands for Portuguese, 7 stands for Spanish, 8 stands for Russian, 9 stands for Turkish).

3. Press OK to save the settings and return to the previous menu.

Chapter 10: Wallpaper



You can choose different wallpaper.

Chapter 11: Version

1 means the first door camera registered in the indoor monitor
Door Camera Version No.

```
C:1.3 20190219
R:1.1 20181126
1#-----
C:1.3 20190321
R:1.1 20161011
M:1.1 20161125
```

Indoor Monitor Version No.

Press Up Δ or Down ∇ to choose “Version” menu, then press OK .

You can check the software version in it.

Chapter 12: Video Set

```
Auto Video Record

ON

OFF
```

1. Press Up Δ or Down ∇ to choose “Video Set.” menu, then press OK to Select .
2. Press Up Δ or Down ∇ to choose On or Off to enable or disable the function.
3. Press OK to save the settings and return to the previous menu.

With this Auto Video Record On, the camera will record the video of visitor automatically when the visitor presses the Call button on the door camera. You can view this record easily on the indoor monitor.

Notes:

1. During the conversation/monitoring, the camera can record the video of visitor and save it into the indoor monitor.
2. The longest time for video recording is 75 seconds.

Chapter 13: Video

1. Press Up Δ or Down ∇ to choose “Video Record.” menu, then press OK to Select. SD card needs to be inserted, otherwise the following interface will appear. When the SD card is inserted, the upper right corner of the interface will appear \blacksquare .



You can view or delete the video record in this menu.

1. Press Up Δ or Down ∇ to choose “View Record” menu.
2. Press OK , and press Up Δ or Down ∇ to view the records.
3. To delete the record, use Up Δ or Down ∇ to choose it and then press OK . The display will show “ trash ? ”. Press OK to confirm.
4. trash : This icon means Delete All. Pressing OK the system will prompt whether to delete all the records. Press OK to delete and press Return to exit.
5. After one warning tone, it will display the next view.
6. Press Return to return to the previous menu.

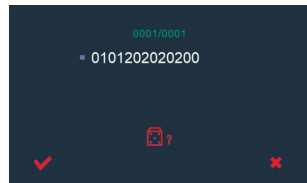
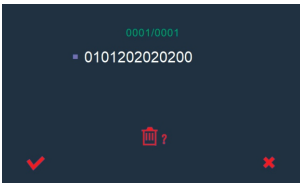

Chapter 14: Default set

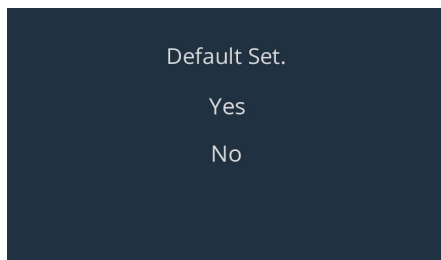

This function allows you to reset the indoor monitor to the factory default.

1. Press Up Δ or Down ∇ to choose "Default Set." menu, then press OK .
2. Press Up Δ or Down ∇ to choose YES or NO to enable or disable the function.
3. Press OK to save the settings and return to the previous menu.





Note: If you reset the indoor monitor, all the settings will return to the factory default.

Result: After resetting, the indoor monitor will return to standby mode.

ENGINEERING MODE

Register

1. Firstly, insert the small screw driver on “” position inside the battery compartment of door camera for 3 seconds. It will give an indication tone and the backlight of call button will lighten.

Secondly, press  on the indoor monitor, select the Register menu, press Up  or Down  to choose one door camera (1-2 are selectable) that you want to connect, and press  to confirm the settings. Then the door camera will automatically search for the indoor monitor which needs to be registered. When the indoor monitor gives an indication tone, it means that it is registered successfully.

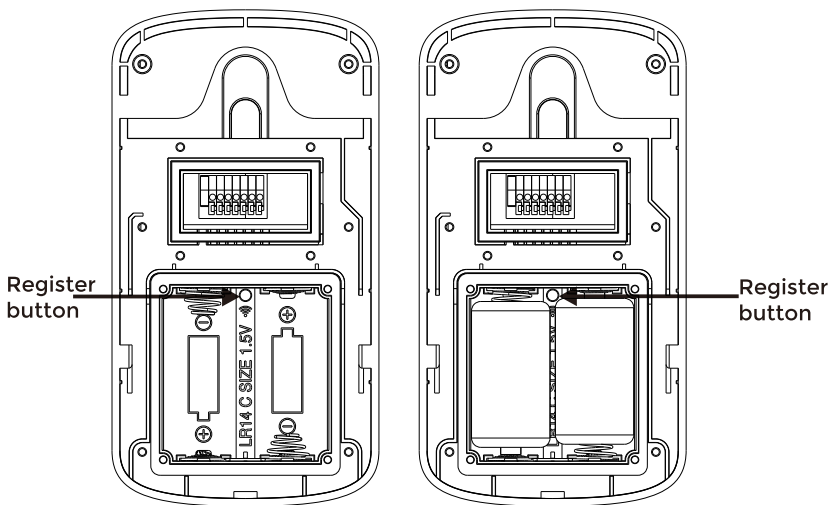

2. Pressing  and then selecting the Register menu, the system will enter into the following interface. It indicates that the indoor monitor is registered successfully.

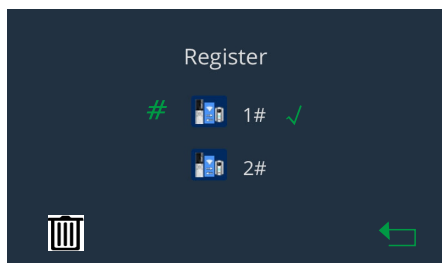

3. If you want to delete the registration, you can press . The screen will show "🗑️?", press  to confirm. Press  to return to the home page.

Notes:

1. The registration of door camera can be up to 60 seconds.
2. The registration of indoor monitor can be up to 20 seconds.
3. The product can support max. 2 door cameras and 2 indoor monitors.

Power Saving Mode

1. If the door camera is battery-powered, the indoor monitor cannot enable monitoring function with factory default. Press Register button for 3 seconds and make the door camera enter the registration status. Press Register button again for 3 seconds. The door camera will give "bi-bi-bi" tone and switch from power saving mode into power consumption mode. Then the monitoring function is available for the indoor monitor.
2. In registration status, press Register button for 3 seconds. The door camera will beep and switch from power consumption mode into power saving mode. In this case, the monitoring function is unavailable.

OPERATIONS

Monitor

As for monitoring function, the LCD will automatically display the corresponding menu in accordance with the registered door camera.

1. In the standby mode, press **OK**.
2. With one door camera registered, the indoor monitor will enter into monitoring mode directly.
3. With two door cameras registered, the LCD will display Monitor 1# and 2#. You can press Up **Δ** or Down **∇** to choose the one you need to watch, then press **OK**.
4. In monitoring mode, press Accept key to enter into intercom communication.

Note: Monitoring time can last up to 45 seconds.

Alarm

When someone takes the door camera apart from the bracket, the door camera and indoor monitor will give alarm. The door camera will first call the main indoor monitor. If the main indoor monitor doesn't respond, the door camera will call the sub indoor monitor. In this case, the call button is invalid on the door camera. Press **🔒** or **🔓** on indoor monitor to stop alarm sounds.

Notes:



1. The alarm time can be up to 5 minutes.
2. During the alarm, door camera can only connect with one indoor monitor.

Calling indoor monitor

If the visitor presses the Call button on the door camera, the corresponding indoor monitor rings and the image of the visitor appears on the LCD of indoor monitor.

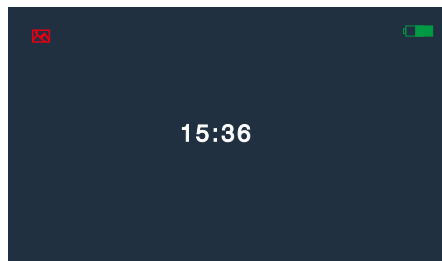
1. If the resident doesn't want to answer, press **🔒** to cancel the call.
2. After the resident presses **🔒**, the indoor monitor will stop ringing. Then the conversation starts. Press **🔒** to end the conversation.



3. When the door camera calls indoor monitor, if the indoor monitor has no operation (press  /  / ), it will return to the main interface. The flashing icon of missed call will show in the upper left corner to remind the user of viewing the images. Pressing the End key in the main interface or viewing picture in the “Snap Show” can cancel the flashing icon.

Note: Missed call icon will be displayed when Auto Snap is enabled.

Notes:

1. The ringing time can be up to 30 seconds.
2. The conversation can be up to 45 seconds. After 45 seconds, the call will be disconnected automatically.

Unlocking

During conversation or monitoring status, press  button to unlock the door.

Backlight

1. If the door camera is supplied by DC 12V, the backlight of call button is on.
2. If the door camera is supplied by battery, the backlight of call button is off.

Note: During the calling, alarm or monitoring status, if the door camera is powered by battery in power saving mode, the backlight of call button will be off.

3. In the registration, calling, alarm, monitoring and intercom status, the backlight will flash.

TECHNICAL PARAMETERS

Item	Detail
Door Camera	
Transmit Frequency Range	2.4GHz - 2.4835GHz
Data Rate	2.0Mbps
Transmitting Power	19dBm (TYP)
Modulation Type	GFSK
Transmitting Distance(in open area)	about 400m
Image Sensor Type	Color CMOS Image sensor
Image Processing	H.264
Camera Pixels	640*480
White Balance	Auto
Viewing Angle (Diagonal)	105°
LED	6 LEDs
Power Requirement	(+9V-12V)±5%/ 2*LR14(C),1.5V batteries
Power Consumption	500mA Max(Cells) 200mA Max(+12 V DC)
Operating Temperature	-20°C~++55°C
Operating Humidity	10%~90%
Size(W* H*D)	86*160*54.4mm
No. of Indoor Monitor Supported	Max.2

Item	Detail
Indoor Monitor	
Receiving Frequency Range	2.4GHz - 2.4835GHz
Monitor	7" Color LCD
Data Rate	2Mbps
Receiving Sensitivity	-85dBm
Demodulation Type	GFSK
LCD Resolution	800X480(RGB)
Transmitting Power	19dBm (TYP)
Power Requirement	3.7V ,2500mA(lithium battery)
Power Consumption	500mA Max
Operating Temperature	-10°C~+55°C
Operating Humidity	10%~90%
Size(W*H*D)	214.85*149.85*21mm
No. of Door Camera Supported	Max.2

INSTALLATION & USAGE

Since working frequency of this product is 2.4G, wavelength is short and wireless signal has poor penetration, the device will get disturbed from other products of the same frequency. In order to ensure smooth communication, please note the following.

1. It's best to install door camera in a place away from rain and wind. Try to avoid the sunlight into camera lens. Do not place the door camera directly on metal security door, because metal will have barrier effect on the signal. Door camera can be installed on the wall nearby.

2. Since the product is straight line transmission, try to reduce the obstacle between door camera and indoor monitor. The obstacle will weaken the signal. In the case that there is the obstruction which affects transmission distance, please shorten the distance between transmitter and receiver if possible when meeting usage needs. When the product goes through different obstructions, general signal attenuation situation is as below:

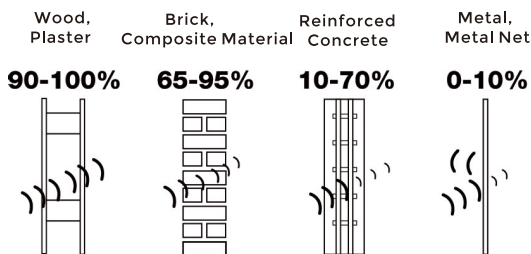

Remaining signal percentage is shown above after radio wave passes through the obstructions of different materials.

3. Do not put any product of the same frequency such as router, bluetooth device and microwave oven next to our device in order to avoid causing the interference and shortening of communication distance. If the number of walls between door camera and indoor monitor results in ineffective communication, please adjust the location of two devices to reduce wall number between two devices over a horizontal distance. When door camera is in communication with indoor monitor, if someone walks on the distance between two devices, the communication might be less effective. The indoor monitor cannot be put in low-lying place or corner.

Away from electrical appliances, such as a TV, personal computer or another cordless phone.

In a HIGH and CENTRAL location with no obstructions such as walls, microwave oven and WIFI.

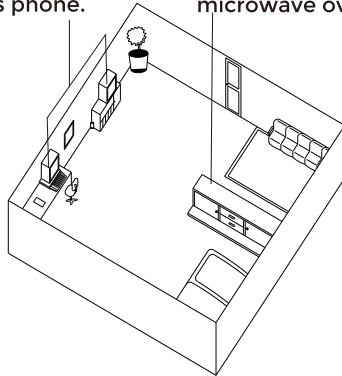

Location Diagram 1 of Indoor Monitor

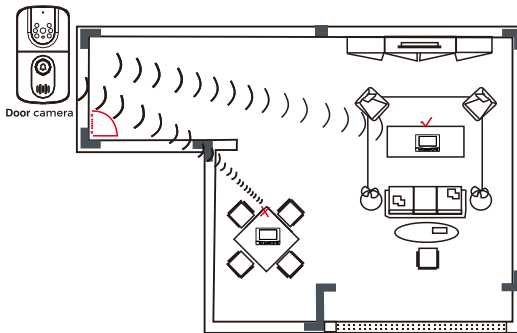

Location Diagram 2 of Indoor Monitor

SAFETY INSTRUCTIONS

In order to protect you and others from harm or protect your device from damage, please read the following information before using the device.

Do not install the device in the following places:

- Do not install the device in high-temperature and moist environment or the area close to magnetic field, such as around electric generator, transformer or magnet.
- Do not place the device near heating products such as electric heater or the fluid container.
- Do not place the device in the sunshine or near the heat source, which might cause discoloration or deformation of the device.
- Do not install the device in an unstable position to avoid the property losses or personal injury caused by the falling of device.

Guard against electric shock, fire and explosion

- Do not use damaged power cord, plug or loose outlet.
- Do not touch the power cord with wet hands or unplug the power cord by pulling.
- Do not bend or damage the power cord.
- Do not touch the device with wet hands.
- Do not make the power supply slip or cause the impact.
- Do not use the power supply without the manufacturer's approval.
- Do not have the liquids such as water go into the device.

Clean Device Surface

- Clean the device surfaces with soft cloth dipped in some water, and then rub the surface with dry cloth.

Other Tips

- In order to prevent damage to the paint layer or the case, please do not expose the device to chemical products, such as the diluent, gasoline, alcohol, insect-resist agents, opacifying agent and insecticide.
- Do not knock on the device with hard objects.
- Please be careful when standing up from under the device.
- Do not disassemble, repair or modify the device at your own discretion. The arbitrary modification is not covered under warranty. When any repair required, please contact the customer service center.
- If there is abnormal sound, smell or fume in the device, please unplug the power cord immediately and contact the customer service center.
- When the device isn't used for a long time, the adaptor and memory card can be removed and placed in dry environment.

 **EASY & SMART
INTERCOM SOLUTIONS**