

MASTER  
STATION

**MODEL:**  
902C-A

QUICK START GUIDE

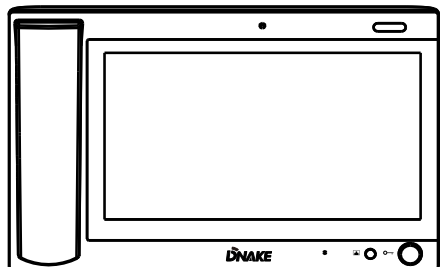

# REMARK

---

Please follow the user manual for correct installation and testing. If there is any doubt please call our tech-supporting and customer center.

Our company applies ourselves to reformation and innovation of our products. No extra notice for any change. The illustration shown here is only for reference. If there is any difference, please take the actual product as the standard.

The product and batteries must be handled separately from household waste. When the product reaches the end of service life and needs to be discarded, please contact the local administrative department and put it in the designated collection points in order to avoid the damage to the environment and human health caused by any disposal. We encourage recycling and reusing the material resources.

# CATALOG

Package Contents .....	1
Pictures .....	1
System Configuration .....	2
System Diagram.....	3
Installation.....	4
Safety Instructions.....	5

**For specific operation instructions, please scan the following QR code to obtain the full version of the User Manual.**



# PACKAGE CONTENTS

Please make sure the package contains the following items:

MODEL: 902C-A

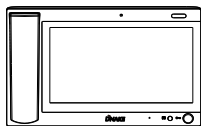

Master Station



Screw



Quick Start Guide

# PICTURES

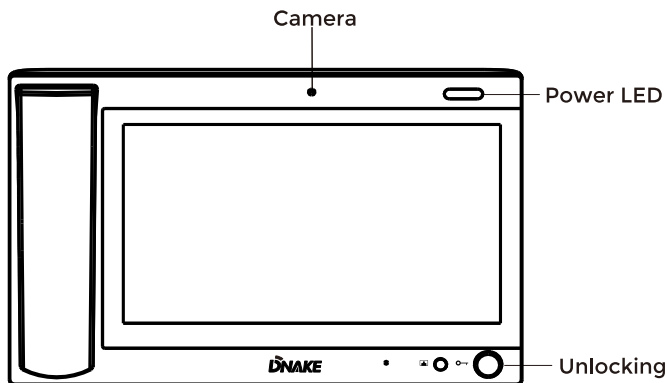

# SYSTEM CONFIGURATION

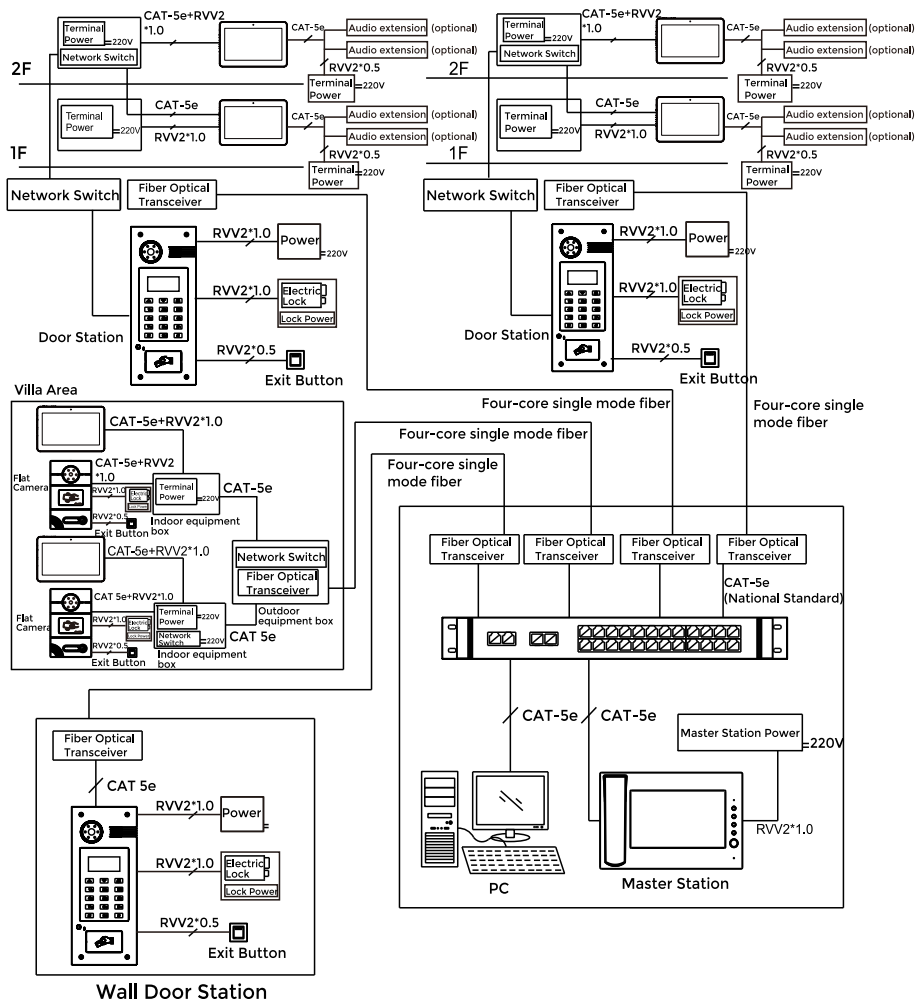

# SYSTEM DIAGRAM

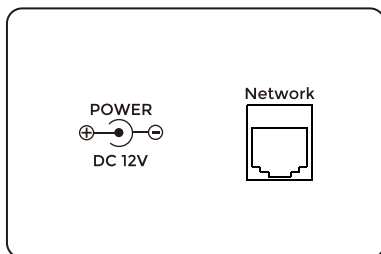

## 1. Power Interface

Power Input Interface of Master Station: connect with 12V DC power supply.

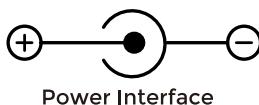

## 2. Network Interface

Connect to door station, indoor monitor or other network device through a switch.

With PoE function, PoE switch can be connected to supply power to master station.

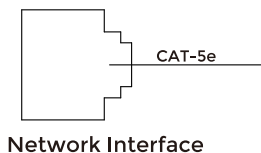

# INSTALLATION

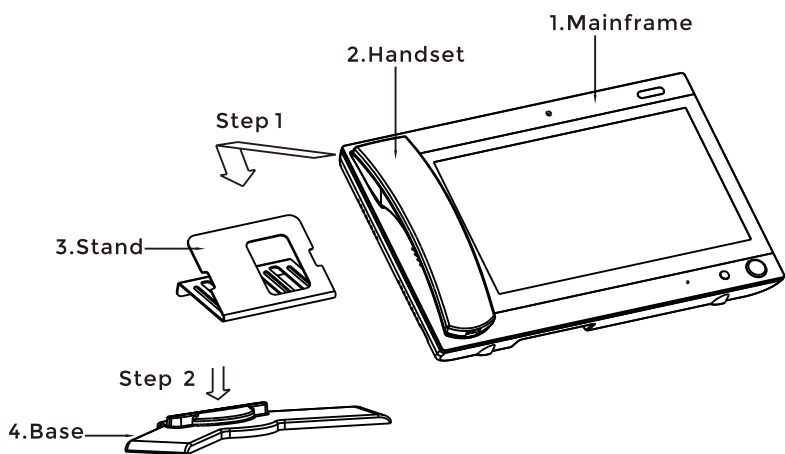

Product size: 303x195x35mm  
Installation: desktop installation

# SAFETY INSTRUCTIONS

In order to protect you and others from harm or your device from damage, please read the following information before using the device.

Do not install the device in the following places:

- Do not install the device in high-temperature and moist environment or the area close to magnetic field, such as the electric generator, transformer or magnet.
- Do not place the device near the heating products such as electric heater or the fluid container.
- Do not place the device in the sun or near the heat source, which might cause discoloration or deformation of the device.
- Do not install the device in an unstable position to avoid the property losses or personal injury caused by the falling of device.

Guard against electric shock, fire and explosion:

- Do not use damaged power cord, plug or loose outlet.
- Do not touch the power cord with wet hand or unplug the power cord by pulling.
- Do not bend or damage the power cord.
- Do not touch the device with wet hand.
- Do not make the power supply slip or cause the impact.
- Do not use the power supply without the manufacturer's approval.
- Do not have the liquids such as water go into the device.

Clean Device Surface

- Clean the device surfaces with soft cloth dipped in some water, and then rub the surface with dry cloth.

Other Tips

- In order to prevent damage to the paint layer or the case, please do not expose the device to chemical products, such as the diluent, gasoline, alcohol, insect-resist agents, opacifying agent and insecticide.
- Do not knock on the device with hard objects.
- Do not press the screen surface. Overexertion might cause flopper or damage to the device.
- Please be careful when standing up from the area under the device.
- Do not disassemble, repair or modify the device at your own discretion.
- The arbitrary modification is not covered under warranty. When any repair required, please contact the customer service center.
- If there is abnormal sound, smell or fume in the device, please unplug the power cord immediately and contact the customer service center.
- When the device isn't used for a long time, the adaptor and memory card can be removed and placed in dry environment.
- When moving, please hand over the manual to new tenant for proper usage of the device.



 **EASY & SMART  
INTERCOM SOLUTIONS**