

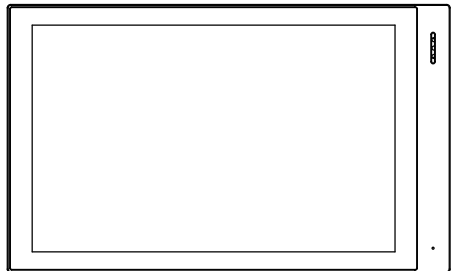

INDOOR  
MONITOR

**MODEL:**

**H218**



QUICK START GUIDE

## REMARK

---

Please follow the user manual for correct installation and testing. If there is any doubt please call our tech-supporting and customer center.

Our company applies ourselves to reformation and innovation of our products. No extra notice for any change.

The illustration shown here is only for reference. If there is any difference, please take the actual product as the standard. The product and batteries must be handled separately from household waste. When the product reaches the end of service life and needs to be discarded, please contact the local administrative department and put it in the designated collection points in order to avoid the damage to the environment and human health caused by any disposal. We encourage recycling and reusing the material resources.

# CATALOG

- Package Contents .....1
- Pictures .....1
- System Diagram .....2
- Device Wiring .....3
- Installation .....5
- Safety Instructions .....7
- FCC Warning .....8

**For specific operation instructions, please scan the following QR code to obtain the full version of the User Manual.**



# PACKAGE CONTENTS

Please make sure the package contains the following items:

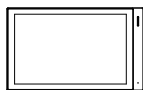

Indoor Monitor

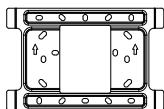

Bracket



Screw



Wires



Resistor(8 pcs)



Desktop Stand  
(Optional)

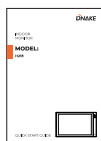

Quick Start Guide

# PICTURES

MODEL: H218

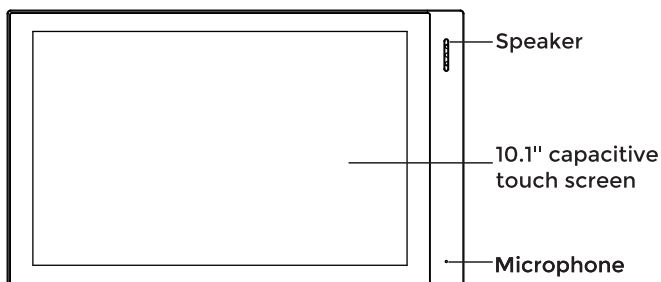

# SYSTEM DIAGRAM

MODEL: H218

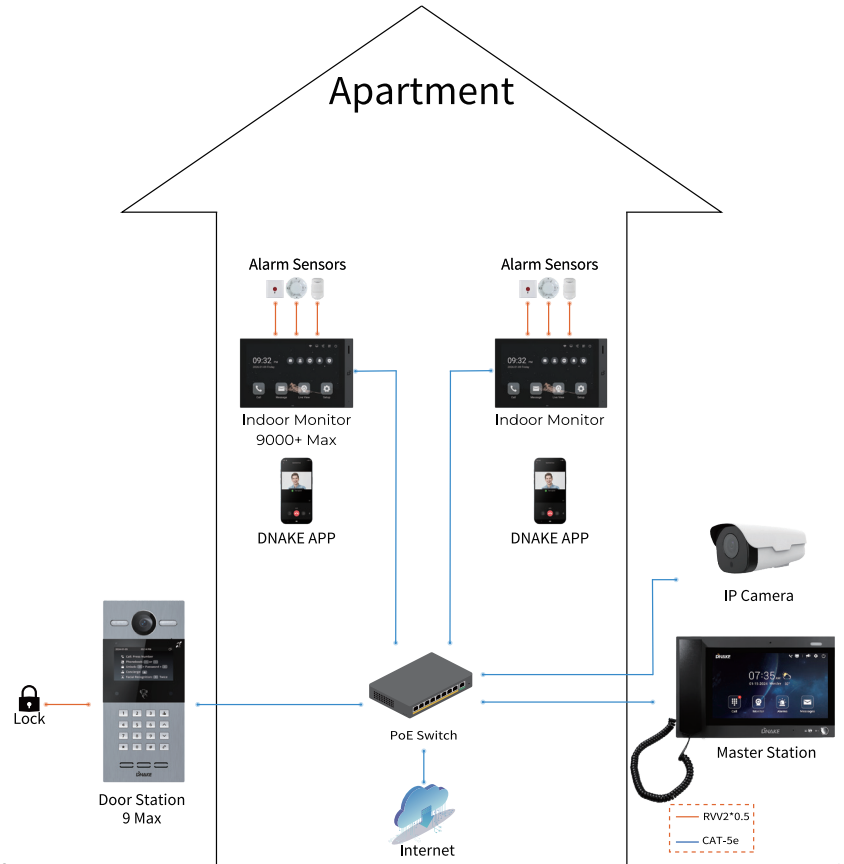

# DEVICE WIRING

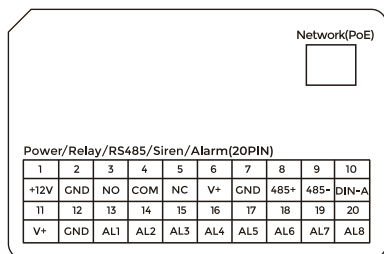

Single Network Port

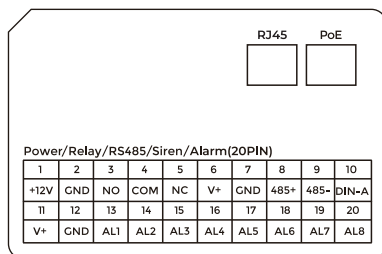

Dual Network Ports

## 1. Network/PoE/RJ45

### Single Port:

Network (PoE) interface is for the connection with PoE switch or other network switch.

### Dual Port:

1. RJ45 interface is for providing the power and network for Villa Station(special version) directly from this Indoor Monitor, so Villa Station doesn't need extra power adaptor.
2. PoE interface is for the connection with PoE switch or other network switch.

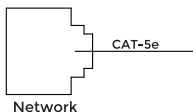

## 2. Power

Power input interface: connect with 12V power adapter.

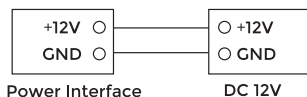

### 3. Relay Output

Connect to the lock module(independent power supply is necessary for the lock).

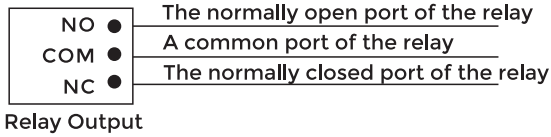

### 4. RS485

Connect with RS485 interface device;

RS485 interface can output 12V/100mA power supply. If RS485 equipment to be connected doesn't require the power supply, no need to connect +12V.

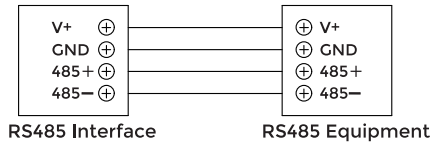

### 5. Siren/Alarm

Interface of alarm zones connects with normally-open or normally-closed switch.

When the alarm zone is triggered, it will output 12V/100mA power.

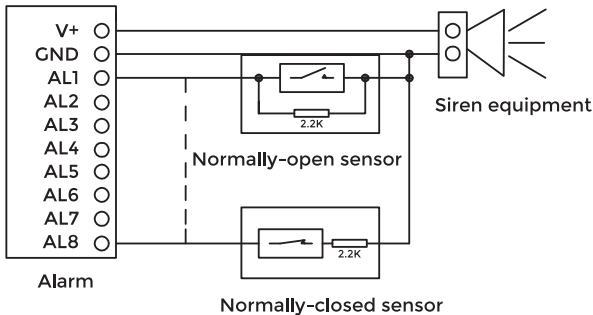

# INSTALLATION

Cut-out Dimension (Unit: mm)

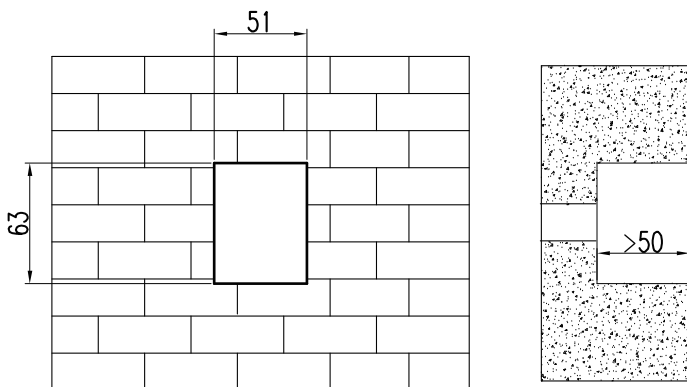

1. Prepare wall opening to specified cut-out dimensions

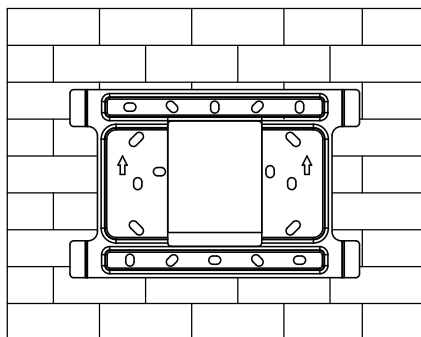

2. Align bracket opening to wall cut-out; drill and screw through top and bottom hole positions.



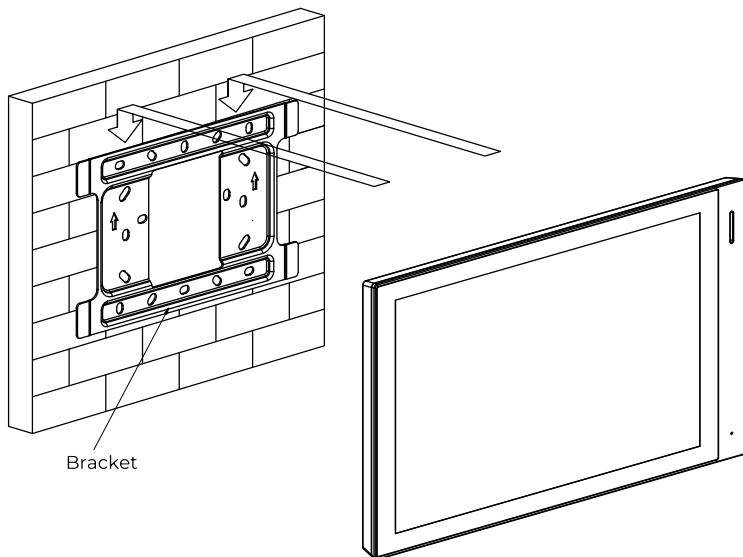

3.Align and engage the four rear slots onto the bracket hooks, then slide downward to install.

Product size: 264.3 x 160 x 12.8 mm

### Installation Instructions:

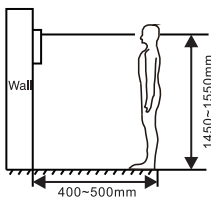

[Suggestion]: The camera should be 1450~1550mm above the ground. The camera at this height can capture human face perfectly.

# SAFETY INSTRUCTIONS

In order to protect you and others from harm or your device from damage, please read the following information before using the device.

Do not install the device in the following places:

- Do not install the device in high-temperature and moist environment or the area close to magnetic field, such as the electric generator, transformer or magnet.
- Do not place the device near the heating products such as electric heater or the fluid container.
- Do not place the device in the sun or near the heat source, which might cause discoloration or deformation of the device.
- Do not install the device in an unstable position to avoid the property losses or personal injury caused by the falling of device.

Guard against electric shock, fire and explosion:

- Do not use damaged power cord, plug or loose outlet.
- Do not touch the power cord with wet hand or unplug the power cord by pulling.
- Do not bend or damage the power cord.
- Do not touch the device with wet hand.
- Do not make the power supply slip or cause the impact.
- Do not use the power supply without the manufacturer's approval.
- Do not have the liquids such as water go into the device.

Clean Device Surface

- Clean the device surfaces with soft cloth dipped in some water, and then rub the surface with dry cloth.

Other Tips

- In order to prevent damage to the paint layer or the case, please do not expose the device to chemical products, such as the diluent, gasoline, alcohol, insect-resist agents, opacifying agent and insecticide.
- Do not knock on the device with hard objects.
- Do not press the screen surface. Overexertion might cause flopover or damage to the device.
- Please be careful when standing up from the area under the device.
- Do not disassemble, repair or modify the device at your own discretion.
- The arbitrary modification is not covered under warranty. When any repair required, please contact the customer service center.
- If there is abnormal sound, smell or fume in the device, please unplug the power cord immediately and contact the customer service center.
- When the device isn't used for a long time, the adaptor and memory card can be removed and placed in dry environment.
- When moving, please hand over the manual to new tenant for proper usage of the device.

# FCC WARNING

This device complies with Part 15 of the FCC Rules. Operation is subject to the following two conditions:

(1) This device may not cause harmful interference, and (2) this device must accept any interference received, including interference that may cause undesired operation.

**NOTE 1:** This equipment has been tested and found to comply with the limits for a Class B digital device, pursuant to part 15 of the FCC Rules. These limits are designed to provide reasonable protection against harmful interference in a residential installation. This equipment generates uses and can radiate radio frequency energy and, if not installed and used in accordance with the instructions, may cause harmful interference to radio communications. However, there is no guarantee that interference will not occur in a particular installation. If this equipment does cause harmful interference to radio or television reception, which can be determined by turning the equipment off and on, the user is encouraged to try to correct the interference by one or more of the following measures:

- Reorient or relocate the receiving antenna.
- Increase the separation between the equipment and receiver.
- Connect the equipment into an outlet on a circuit different from that to which the receiver is connected.
- Consult the dealer or an experienced radio/TV technician for help.

**NOTE 2:** Any changes or modifications to this unit not expressly approved by the party responsible for compliance could void the user's authority to operate the equipment.

## **RF exposure statement**

This equipment complies with the FCC radiation exposure limits set forth for an uncontrolled environment. This transmitter must not be co-located or operating in conjunction with any other antenna or transmitter.



**EASY & SMART  
INTERCOM SOLUTIONS**