

DNAKE

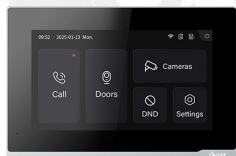

User Manual

DNAKE IPK07

REMARK

Please follow the user manual for correct installation and testing. If there is any doubt please call our tech-supporting and customer center.

Our company applies ourselves to reformation and innovation of our products. No extra notice for any change. The illustration shown here is only for reference. If there is any difference, please take the actual product as the standard.

The product and batteries must be handled separately from household waste. When the product reaches the end of service life and needs to be discarded, please contact the local administrative department and put it in the designated collection points in order to avoid the damage to the environment and human health caused by any disposal. We encourage recycling and reusing the material resources.

CATALOG

PRODUCT FEATURE	1
TECHNICAL PARAMETER.....	1
PACKAGE CONTENT	3
OVERVIEW	4
SYSTEM DIAGRAM.....	5
DEVICE WIRING	6
INSTALLATION	11
BASIC OPERATION-USER	18
BASIC OPERATION-INSTALLER	31
TROUBLESHOOTING.....	33
SAFETY INSTRUCTION.....	35
FCC WARNING.....	37

PRODUCT FEATURE

1. Plug & Play
2. IK07 & IP65
3. Standard PoE
4. Multiple Unlock methods (Card, Temp key, QR code, APP, Indoor monitor)
5. Check alarm notifications on the APP
6. CCTV integration

TECHNICAL PARAMETER

Indoor Monitor E217

Power Supply: PoE (802.3af) or DC 12V/2A

Standby Power: 1.5 W

Rated Power: 9 W

Display: 7-inch TFT LCD

Screen: Capacitive touchscreen

Resolution: 1024 x 600

Working Temperature: -10°C to +55°C

Storage Temperature: -40°C to +70°C

Working Humidity: 10% to 90% (non-condensing)

Villa Station S212

Power Supply: PoE (802.3af) or DC 12V/2A

Standby Power: 1.5 W

Rated Power: 3.5 W

Video Resolution: 1280 x 720

Working Temperature: -40°C to +55°C

Storage Temperature: -40°C to +70°C

Working Humidity: 10% to 90% (non-condensing)

PACKAGE CONTENT

MODEL: IPK07



E217



Wiring Cover



PM4x20 (2 pcs)



Diode (2 pcs)



S212



Wiring Cover



Sealing Plug of
Wiring Port



Junction Pressing



PM2.5x6 (4 pcs)



Rear Cover



Screw Fixing Seat
(2 pcs)



PA4x25 (2 pcs)



PM4x30 (2 pcs)



FM3x4.5 (2 pcs)



Wrench Screw
(T10)



Wires



User Manual

OVERVIEW

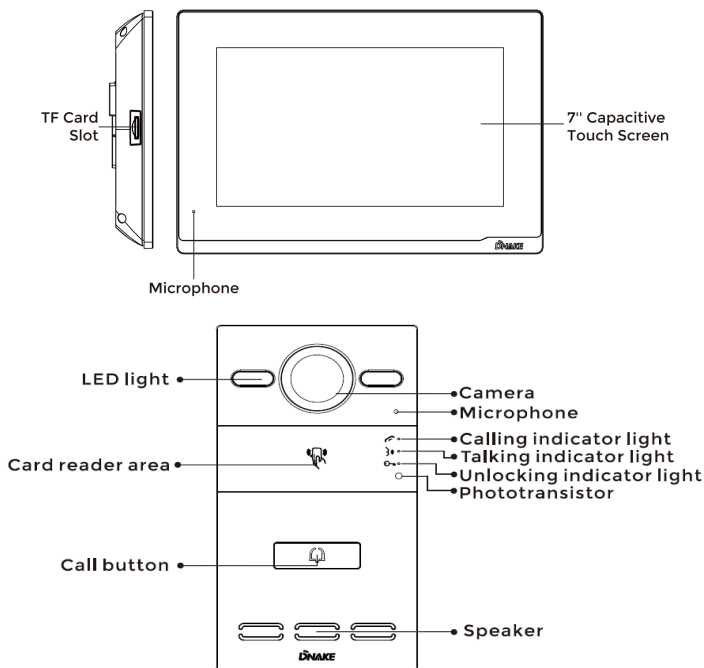

Note:

Calling indicator light: The 1st indicator light will activate if the call button is pressed.

Talking indicator light: The 2nd indicator light will activate if the call is picked up or the Villa Station is being actively monitored.

Unlocking indicator light: The 3rd indicator light activates for 3 seconds when the door is unlocked.

Relay Outputs: Supports 2 relay outputs.

SYSTEM DIAGRAM

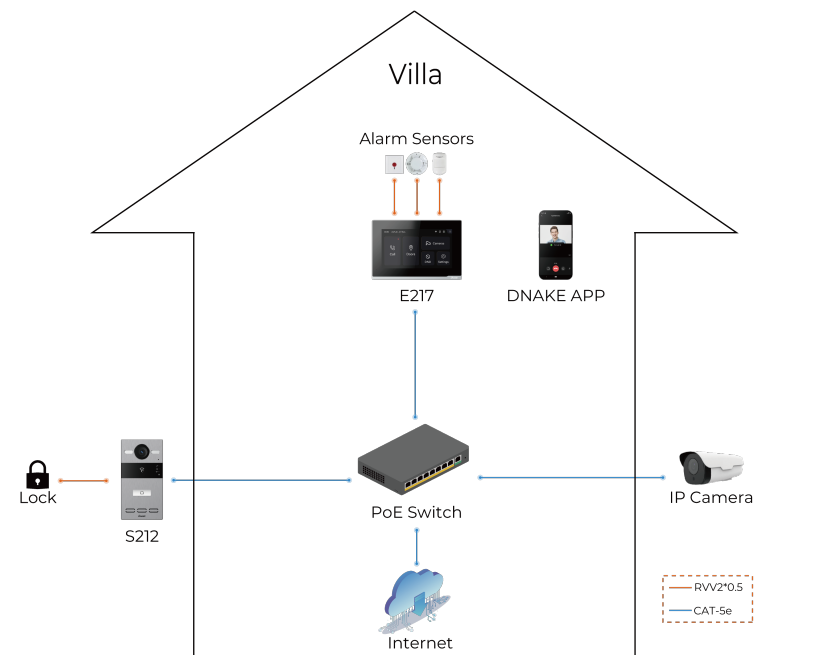

3. Relay Output

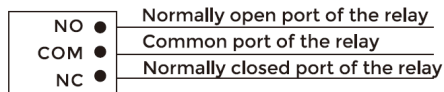

Relay Output

⚠ Warning!

1. When connecting to an inductive load device such as a relay or electromagnetic lock, you are recommended to use a diode 1A/400V (included in the accessories) in anti-parallel with the load device to absorb inductive load voltage peaks. The intercom will be better protected in this way.
2. The load current of the relay cannot be greater than 2A. See attached picture for more details.

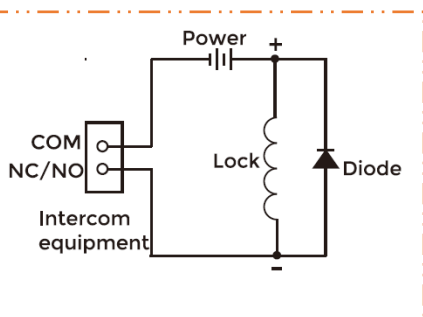

4. RS485

Enable to connect equipment with RS485 interface. RS485 interface can output 12V/100mA power supply. If RS485 equipment to be connected doesn't require the power supply, there is no need to connect to +12V.

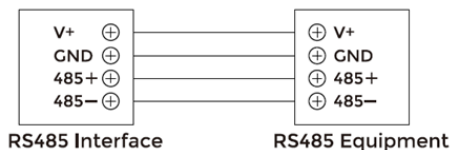

5. Siren/Alarm

Interface of alarm zones connects with normally-open or normally-closed switch. When the alarm zone is triggered, it will output 12V/100mA power.

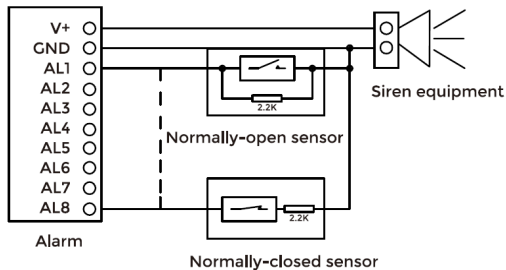

S212

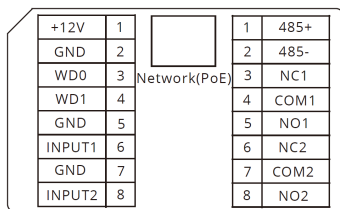

1. Network (PoE) / RJ45 (Non-standard PoE)

Standard RJ45 interface is for the connection with PoE switch or other network switch.

PSE shall comply with IEEE 802.3af (PoE) and its output power not less than 15.4W and its output voltage not be less than 50V.

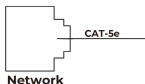

2. Power

The power interface of Door Station connects to 12V DC power.

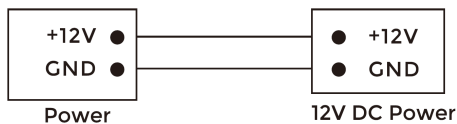

3. Exit/Door-detector/Fire Fighting Linkage

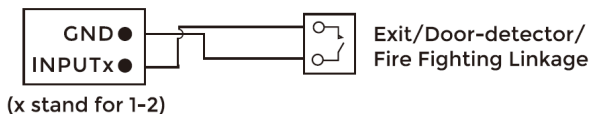

4. RS485/Switching Value Output

Enable to connect equipment with RS485 interface.

Connect to the lock module (an independent power supply is necessary for the lock).

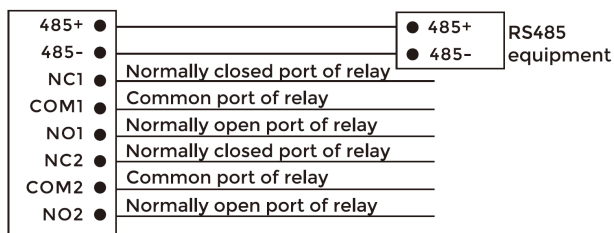

RS485/Switching Value Output

Warning!

1. When connecting to an inductive load device such as a relay or electromagnetic lock, you are recommended to use a diode 1A/400V (included in the accessories) in anti-parallel with the load device to absorb inductive load voltage peaks. The intercom will be better protected in this way.
2. The load current of the relay cannot be greater than 2A. See attached picture for more details.

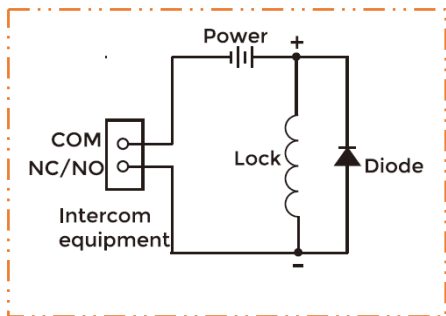

5. Card Reader Interface

The interface can be connected to one IC/ID card reader or be used for reading the information of built-in card reader.

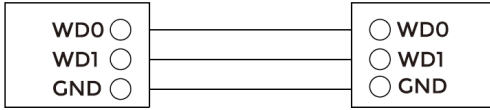

Card Reader Interface

IC/ID Card Reader or Management Device

Note: Door Station can only be connected to one card reader or management device at a time.

INSTALLATION

Cut-out Dimension for Surface Mounting Box(Unit: mm)

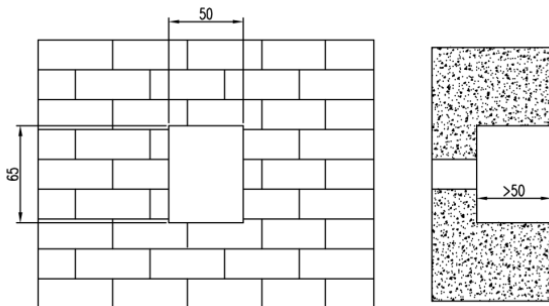

Monitor Surface Mounting:

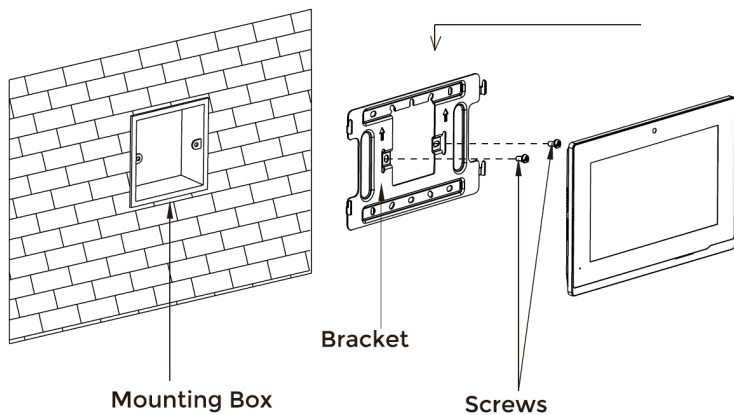

Product size: 195 × 130 × 21 mm

Installation of Wiring Cover

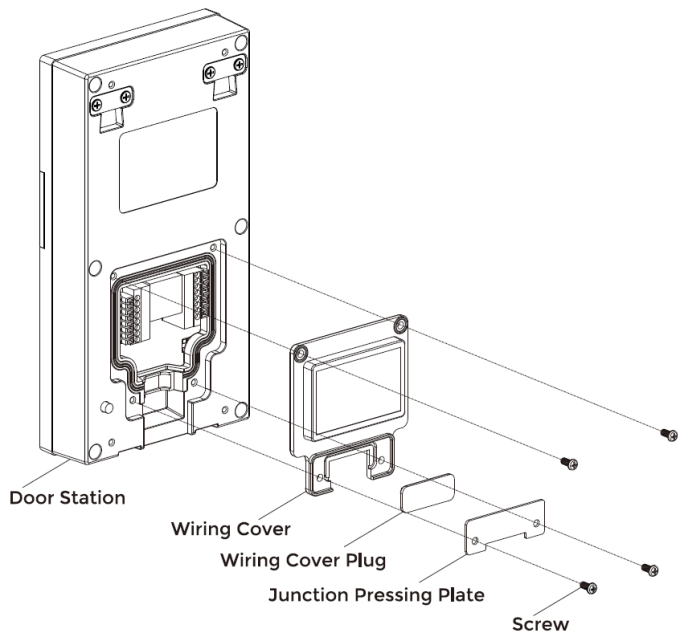

Surface Mounting-86 Mounting Box

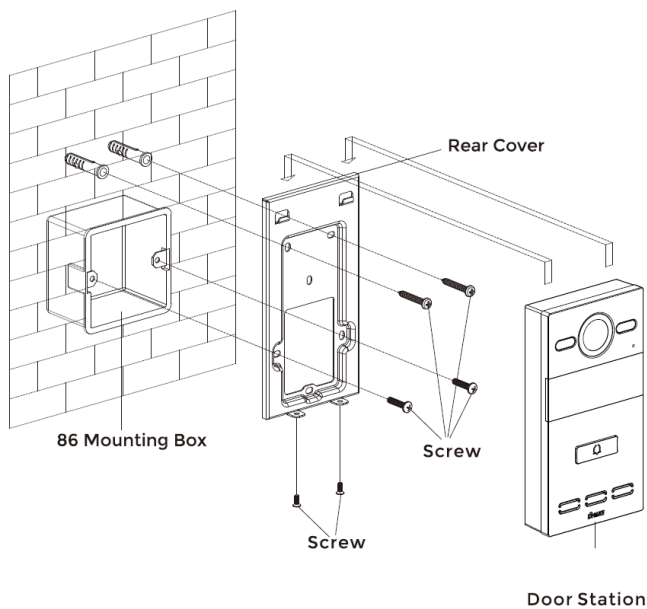

Product size: 88 × 168 × 32.5
mm

Surface Mounting size: 88 × 168 × 34
mm

Surface Mounting-118 Mounting Box

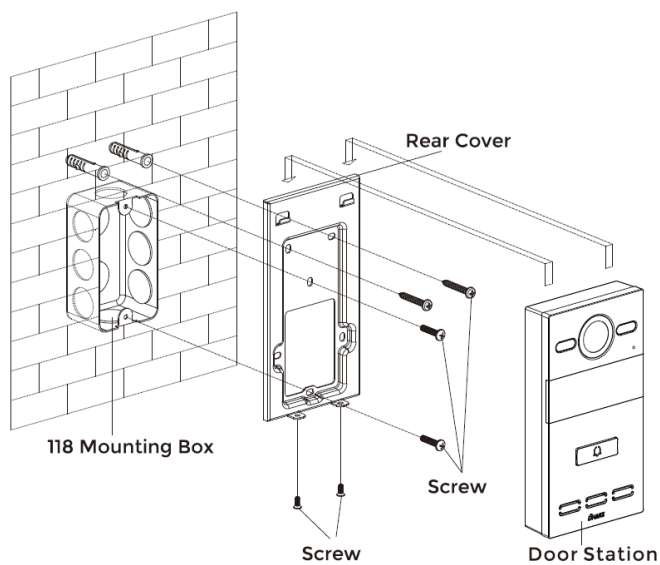

Product size: 88 × 168 × 32.5
mm

Surface Mounting size: 88 × 168 × 34
mm

Flush Mounting

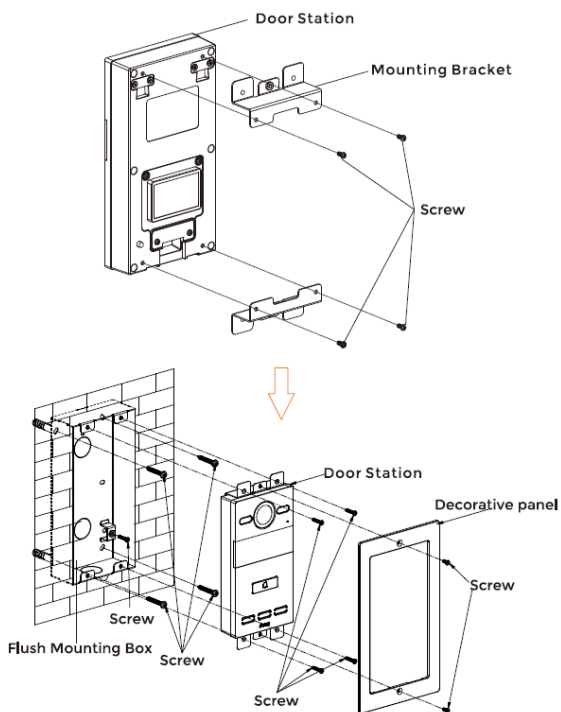

Product size: 88 × 168 × 32.5 mm
Flush Mounting size: 120 × 210 × 48 mm
Hole-cutting size: 98 × 199 × 42 mm

Surface Mounting-86 Mounting Box & Rain Hood (Optional)

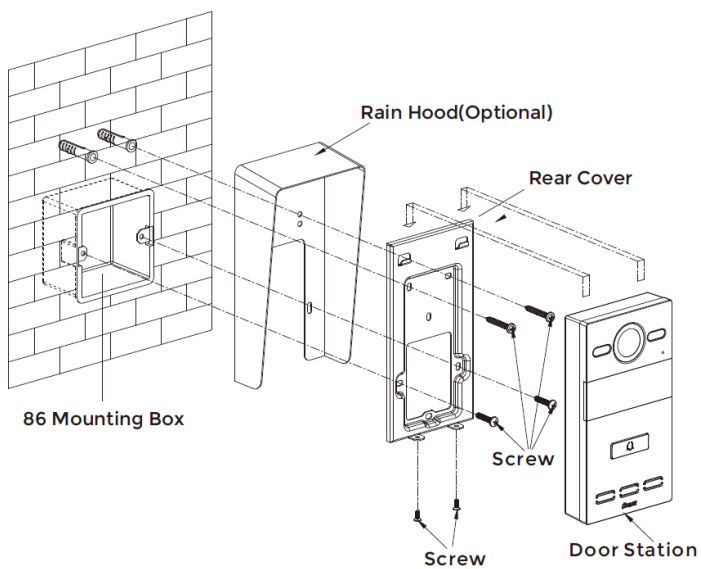

Product size: 88 × 168 × 32.5
mm

Surface Mounting size: 88 × 168 × 34
mm

Surface Mounting-118 Mounting Box & Rain Hood (Optional)

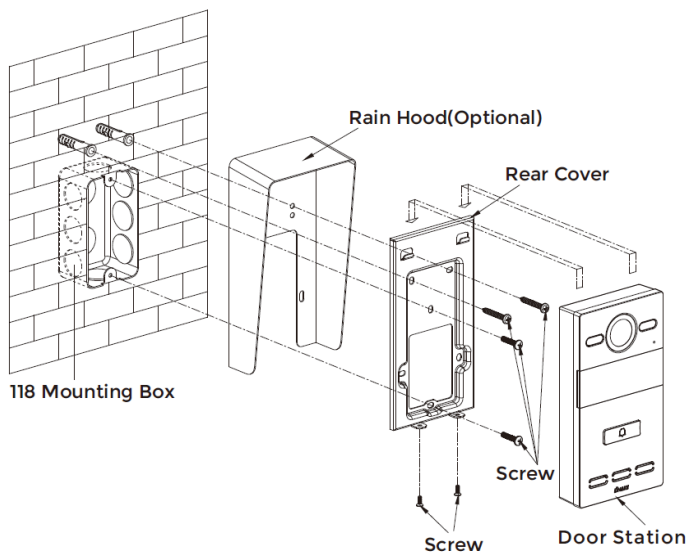

Product size: 88 × 168 × 32.5 mm

Surface Mounting size: 88 × 168 × 34 mm

Tips:

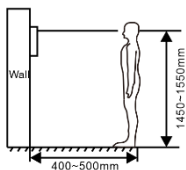

The camera should be 1450~1550mm above the ground.
The camera at this height can capture human face

BASIC OPERATION-USER

1. Onboarding

1.1. Language

16 kinds of languages supported (Chinese Simplified, Chinese Traditional, English, Spanish, German, Polish, Russian, Turkish, Hebrew, Arabic, Portuguese, French, Italian, Slovak, Vietnamese, and Dutch).

Choose language and click Next to move on.

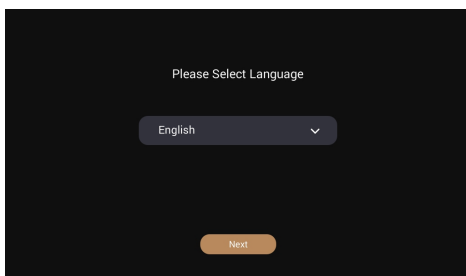

1.2. Password

Create new admin password for indoor monitor.

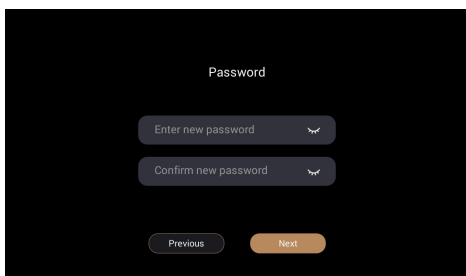

1.3. Network Settings

Set up network.

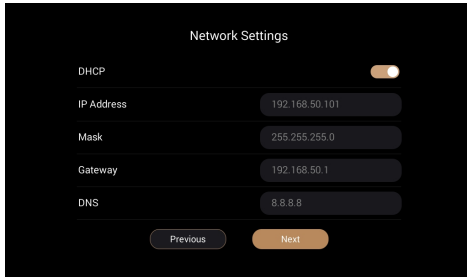

1.4. Wi-Fi Setting

If no Internet with network cable, enable and connect your Wi-Fi.

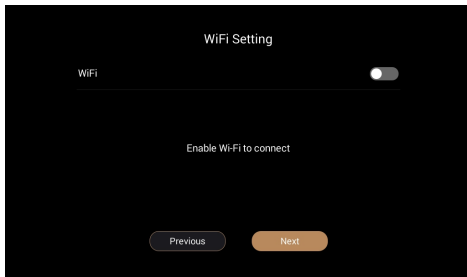

1.5. Device Mode

Choose Main Indoor Monitor if this is your 1st indoor monitor. Otherwise choose Sub Indoor Monitor. Fill in Apartment No. (0-9899)

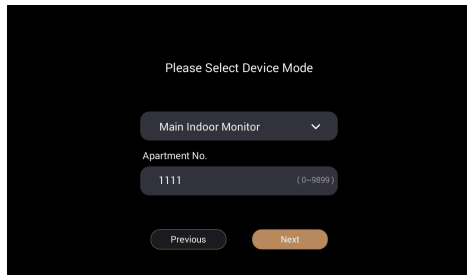

1.6. Villa Station Sync

1. Click Edit icon to set up Villa Station now or click Next to move on.

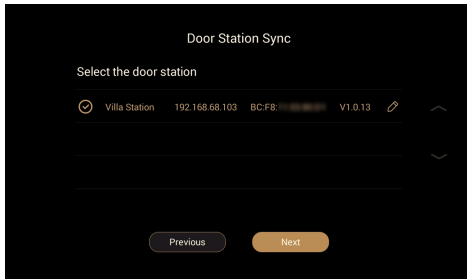

2. Villa Stations' settings are still available on homepage > Settings > Doors > Edit.

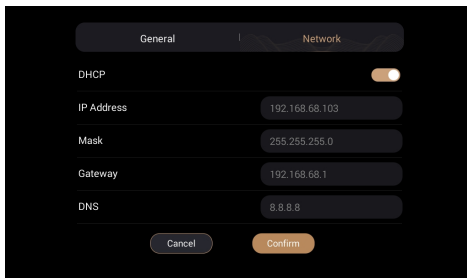
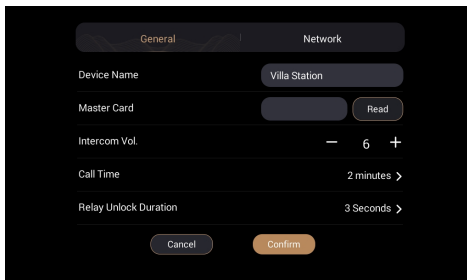

1.7. Cloud Service

Enable Cloud Service.

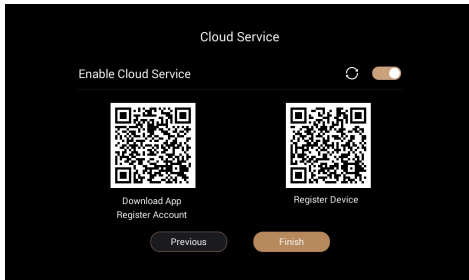

2. DNAKE Smart Pro APP

2.1. Download APP

Scan 1st QR Code to download DANKE Smart Pro APP.

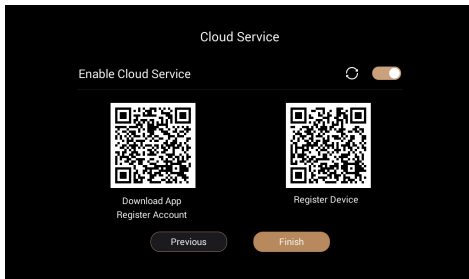

2.2. Register APP account

1. Choose your country and then scan 1st QR Code again with the app. QR code scan tool is on the right upper corner.

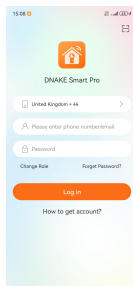

2. Fill in your email address, and click on Get Code to get the verification code in your inbox. Agree to Privacy Policy and User Agreement to register your Account.

3. Fill in Account information to log in. Grant the app permission. Otherwise, some functions may not be available.

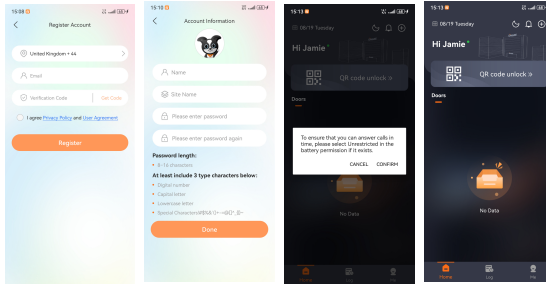

2.3. Register Device

1. Scan 2nd QR code on indoor monitor to register devices.

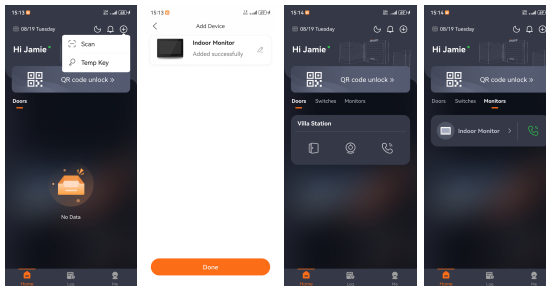

2. Click Finish to go to Homepage. QR code icon is still available on the upper right corner. Users can register or invite family members to scan and join.

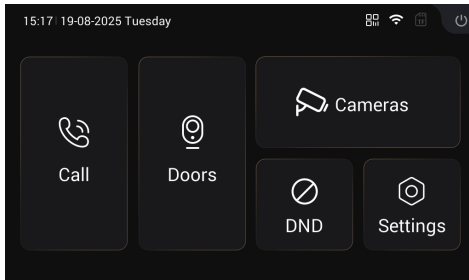

3. Add Sub Indoor Monitor (6 max in total)

Follow the same onboarding pages but choose Sub Indoor Monitor.

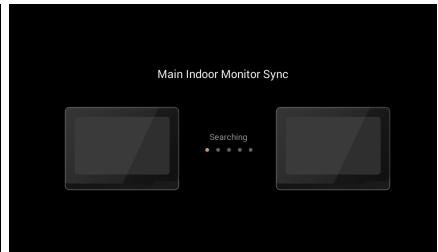
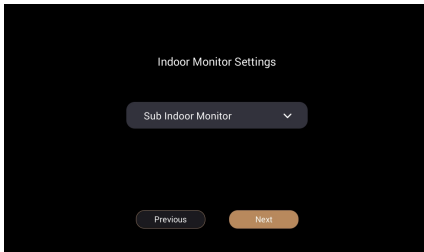

4. Add More Door Stations (2 max in total)

Go to Settings > Doors and press search icon to search for more Door Stations.

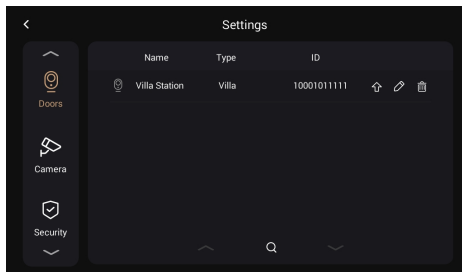

5. Read Cards

5.1. Read Cards by Master Card

1. Go to Settings > Doors and press on the edit icon to find Master Card.

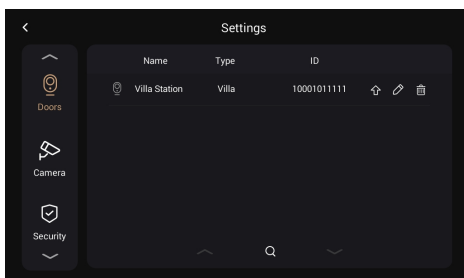

2. Press Read icon and tap your card on Villa Station. After confirming, tapped card becomes Master Card.

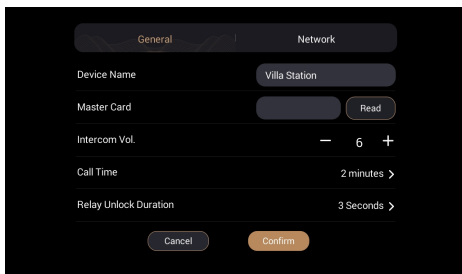

3. Cards used for unlock can be registered by Master Card.
 - a) Add other cards: Tap your Master Card once and then tap other cards immediately. Other cards you have tapped can be used to unlock. Tap Master Card again to finish.
 - b) Delete other cards one by one: Tap your Master Card twice and then tap other cards immediately. Other cards you have tapped will be deleted. Tap Master Card again to finish.
 - c) Delete all other cards: Tap your Master Card five times. All the other cards will be deleted.

Please note that Master Card can only be used to manage cards. It cannot be used to unlock.

5.2. Read Cards for Each Resident

1. Go to Settings > More > Resident and press plus icon to create a resident.

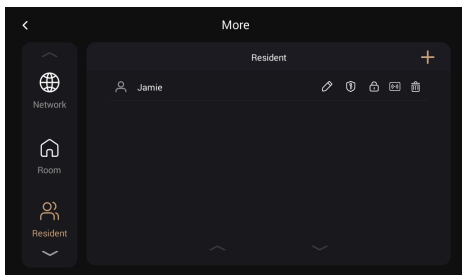

2. Press Card, the 4th icon. (3 cards for each)

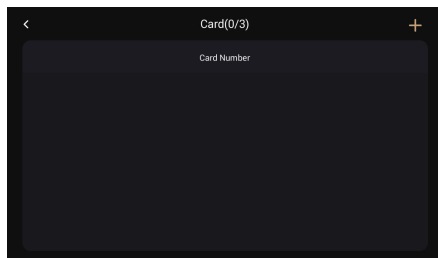
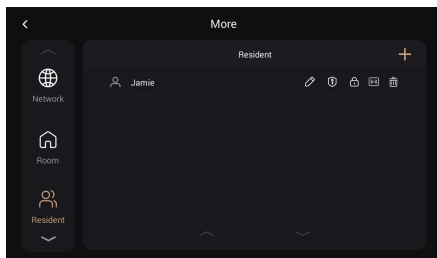

3. Press Read and tap card on Villa Station.

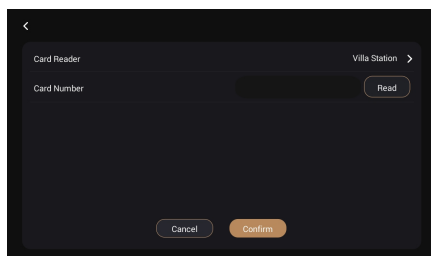

4. Press Shield, the 2nd icon.

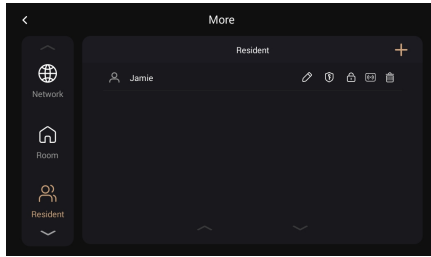

5. Select Villa Stations and Relays for resident's access authority.

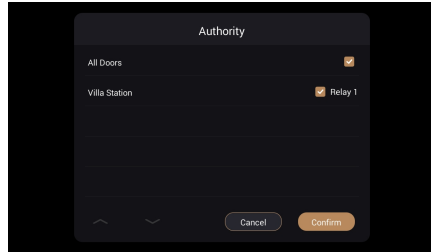

6. PIN Code

1. Go to Settings > More > Resident and press plus icon to create a resident.

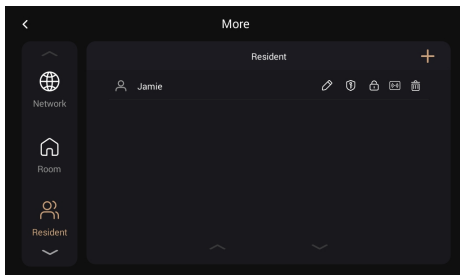

2. Press Lock, the 3rd icon to create a PIN Code for resident.

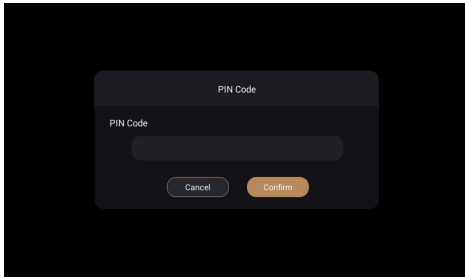

7. Press Villa Station to Call

Press the button on Villa Station to call. You can answer, reject, unlock the door or adjust the volume. Screenshot and video recording are also available.

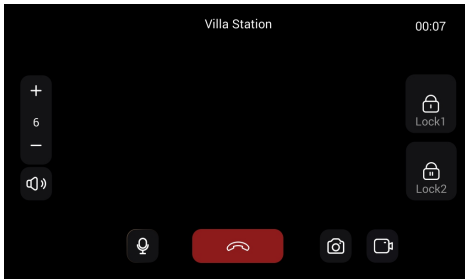

8. Make a Call between Indoor Monitor and APP

8.1. Call Indoor Monitor with APP

Press Monitors and the dial icon to call Indoor Monitor.

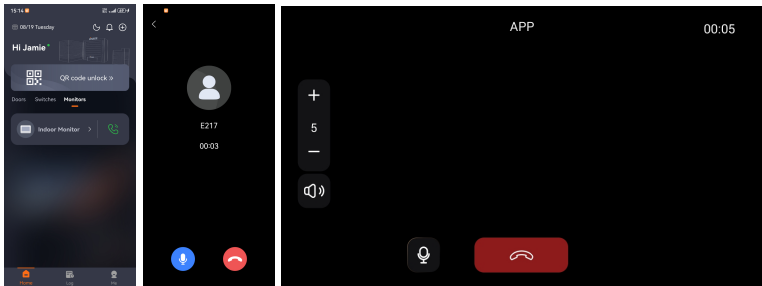

8.2. Call APP with Indoor Monitor

Go to Call > Contacts. Select App and press dial icon below.

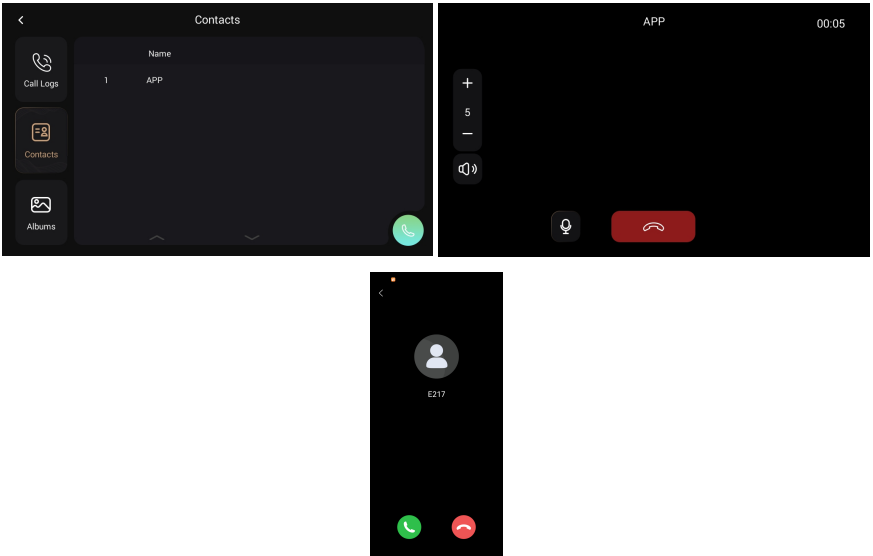

9. Homepage Functions

9.1. Call

Call Logs with screenshot can be checked. Contacts are convenient for making a direct call. And albums are for showing screenshots and recorded-videos in TF card.

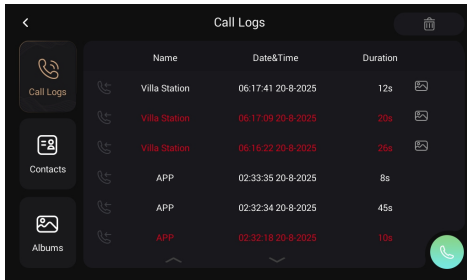

9.2. Doors

Press Doors to monitor. The arrow above is for switching devices.

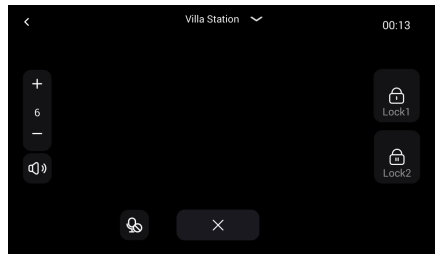
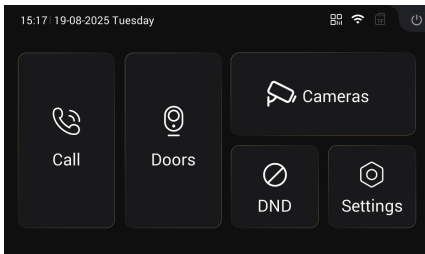

9.3. Cameras

Cameras is for monitoring IP cameras. Cameras can be added by RTSP or ONVIF in Settings.

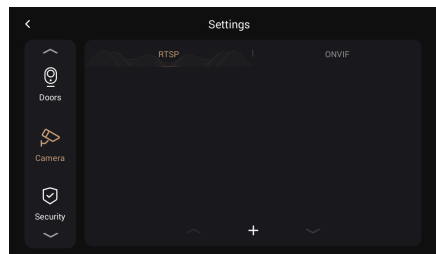
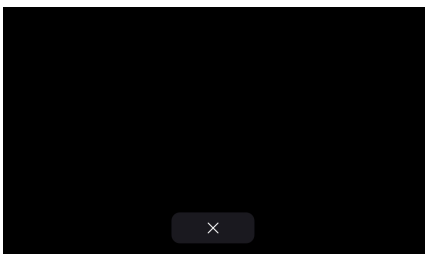

9.4. DND

A shortcut for DND function. DND time can be set up in Settings.

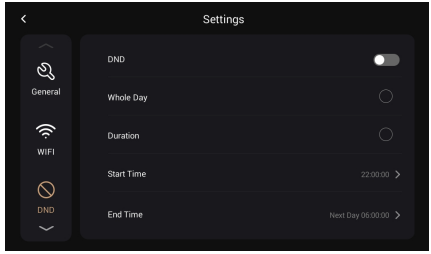
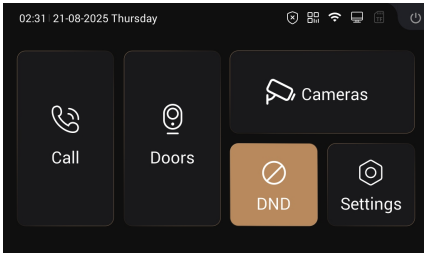

9.5. Settings

Indoor Monitor's Settings.

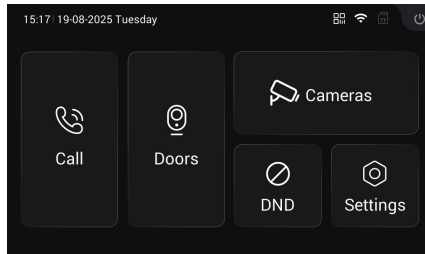

9.6. Little Icons

Security, QR code, Wi-Fi status, network status, TF card status and Screen Sleep functions are all in the upper right corner.

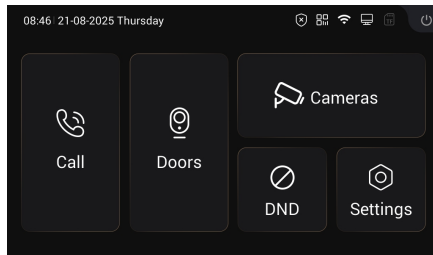

BASIC OPERATION-INSTALLER

Introduction

This part is only for installer. End user can skip this part. First and foremost, installer need to contact DNAKE distributor for installer account of DNAKE Cloud Platform. Only Master/Main Indoor Monitor can be added to the platform and APP account can be managed on the cloud. IPK Villa Station is not supported on the cloud. Get to know more about the platform from DNAKE Distributor or visit DNAKE official website.

1. Add devices to DNAKE Cloud Platform

1.1 Create New Single Family

1. Log in installer account and go to Site.
2. Go to Single-Family to create New Single-Family.

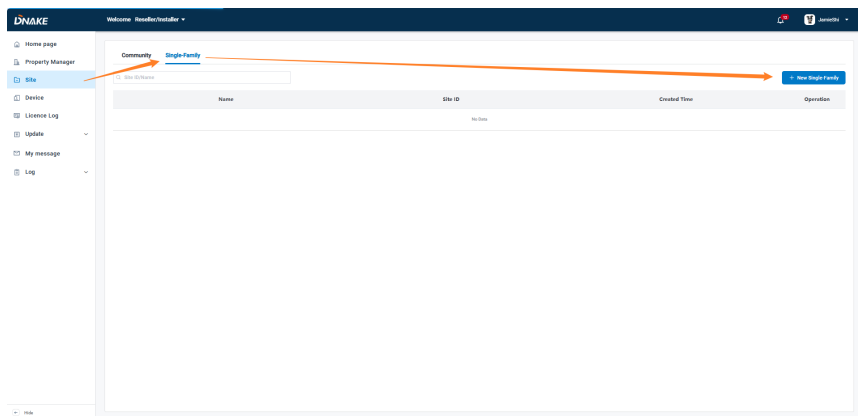

3. Fill in all necessary information. Choose With Indoor Monitor if you have indoor monitor. Only indoor monitor from IPK can be added to the cloud.

DNAME | Welcome | Dashboard | Settings

Home page | Property Manager | **Site** | Device | License Log | Update | My message | Log

← New Single Family

Name *
IPK

Location/Region *
UK (07704830)

Language *
English

License Method *
BY Indoor Monitor

[Add New Device to this site later](#)

Device Type *
Indoor Monitor

MAC *
000000000000

Model or Item *
Indoor

Device ID *
0

Serial Number *
E237

Associated Security *
 Associated Not associated

Network Card ID *
Local Network

Daylight saving time

Cancel Save

1.2 Check devices

1. It may show offline and failed before going through indoor monitor's onboarding pages. Indoor Monitor can also be added here.

DNAME | Welcome | Dashboard | Settings

Home page | Property Manager | **Site** | **Device** | License Log | Update | My message | Log

[Template Download](#)

MAC	Site Type	Site Name	Building/Unit/Apartment	Device Name	Device Type	Model	Status	Sync Status	Operations
BCF811023724	Single Family Home	IPK	1-1-1	E237	Indoor Monitor	-	Offline	None	<input type="button" value="Refresh"/> <input type="button" value="Add"/> <input type="button" value="Remove"/> <input type="button" value="Edit"/>

Total: 13 pages

2. Follow Onboarding pages

1. Refer to the USER BASIC OPERATION to finish onboarding pages. Only 1st QR code needs to be scanned. Devices would go online and show up in the app automatically after going through onboarding pages.

TROUBLESHOOTING

The Indoor Monitor cannot start up or power off automatically.

- Check whether it has power-failure, and power it on again
-

The Indoor Monitor display screen is too dim.

- Check whether the brightness and contrast settings of screen are correct.
-

No sound during the communication.

- Check whether the Indoor Monitor is set as mute mode, or the volume is set to the lowest.
-

The Indoor Monitor cannot monitor the Door Station.

- Other user is using the system, so you can use it once he/she finished the operation.
-

Multimedia files cannot be played normally.

- Check whether the system supports the file format. Please refer to the multimedia setting for details.
-

No response when clicking Indoor Monitor display screen.

- Press "Unlock" button for 5s, or slowly slide horizontally or vertically on the LCD to make touchscreen calibration. It needs to be calibrated.
-

Touchscreen responses slowly or cannot make calibration.

- Take down any protective paster, since it may affect identification
 - and input for device;
 - Ensure the finger is dry and clean when clicking touchscreen;
 - Restart the device to clear any temporary software error.
-

The temperature of device is too high.

- Long-term use leads to high temperature. It's normal and will not affect the device's use life and performance.
-

SAFETY INSTRUCTION

In order to protect you and others from harm or your device from damage, please read the following information before using the device.

- Do not install the device in the following places:
- Do not install the device in high-temperature and moist environment or the area close to magnetic field, such as the electric generator, transformer or magnet.
- Do not place the device near the heating products such as electric heater or the fluid container.
- Do not place the device in the sun or near the heat source, which might cause discoloration or deformation of the device.
- Do not install the device in an unstable position to avoid the property losses or personal injury caused by the falling of device.

Guard against electric shock, fire and explosion:

- Do not use damaged power cord, plug or loose outlet.
- Do not touch the power cord with wet hand or unplug the power cord by pulling.
- Do not bend or damage the power cord.
- Do not touch the device with wet hand.
- Do not make the power supply slip or cause the impact.
- Do not use the power supply without the manufacturer's approval.
- Do not have the liquids such as water go into the device.

Clean Device Surface

- Clean the device surfaces with soft cloth dipped in some water, and then rub the surface with dry cloth.

Other Tips

- In order to prevent damage to the paint layer or the case, please do not expose the device to chemical products, such as the diluent, gasoline, alcohol, insect-resist agents, opacifying agent and insecticide.
- Do not knock on the device with hard objects.
- Do not press the screen surface. Overexertion might cause flopper or damage to the device.
- Please be careful when standing up from the area under the device.
- Do not disassemble, repair or modify the device at your own discretion.

- The arbitrary modification is not covered under warranty. When any repair required, please contact the customer service center.
- If there is abnormal sound, smell or fume in the device, please unplug the power cord immediately and contact the customer service center.
- When the device isn't used for a long time, the adaptor and memory card can be removed and placed in dry environment.
- When moving, please hand over the manual to new tenant for proper usage of the device.

FCC WARNING

This device complies with Part 15 of the FCC Rules. Operation is subject to the following two conditions:

(1) This device may not cause harmful interference, and (2) this device must accept any interference received, including interference that may cause undesired operation.

NOTE 1: This equipment has been tested and found to comply with the limits for a Class B digital device, pursuant to part 15 of the FCC Rules. These limits are designed to provide reasonable protection against harmful interference in a residential installation. This equipment generates uses and can radiate radio frequency energy and, if not installed and used in accordance with the instructions, may cause harmful interference to radio communications.

However, there is no guarantee that interference will not occur in a particular installation. If this equipment does cause harmful interference to radio or television reception, which can be determined by turning the equipment off and on, the user is encouraged to try to correct the interference by one or more of the following measures:

- Reorient or relocate the receiving antenna.
- Increase the separation between the equipment and receiver.
- Connect the equipment into an outlet on a circuit different from that to which the receiver is connected.
- Consult the dealer or an experienced radio/TV technician for help.

NOTE 2: Any changes or modifications to this unit not expressly approved by the party responsible for compliance could void the user's authority to operate the equipment.

RF exposure statement

This equipment complies with the FCC radiation exposure limits set forth for an uncontrolled environment. This transmitter must not be co-located or operating in conjunction with any other antenna or transmitter.

 **EASY & SMART
INTERCOM SOLUTIONS**

 **DNAKE**